

작업공정사진철

고객명:

공사명: AIR COMPRESSOR MOTOR OVERHAUL

규격: AC MOTOR 100HP 2P 380V 60Hz

REPAIR 내역: 분해 조립 및 조립부품 불순물 CLEANSING
양측 HOUSING METALLIZING 연마
BALANCING 및 UNBALANCE교정
BEARING 교환
입 출고검사 시운전 TEST



<http://jinyangmotor.com/>



JIN YANG

작업 공정 사진

작업공정

AC MOTOR 100HP 2P 입고검사



Ass'y

분해 전

작업공정

AC MOTOR 100HP 2P 입고검사

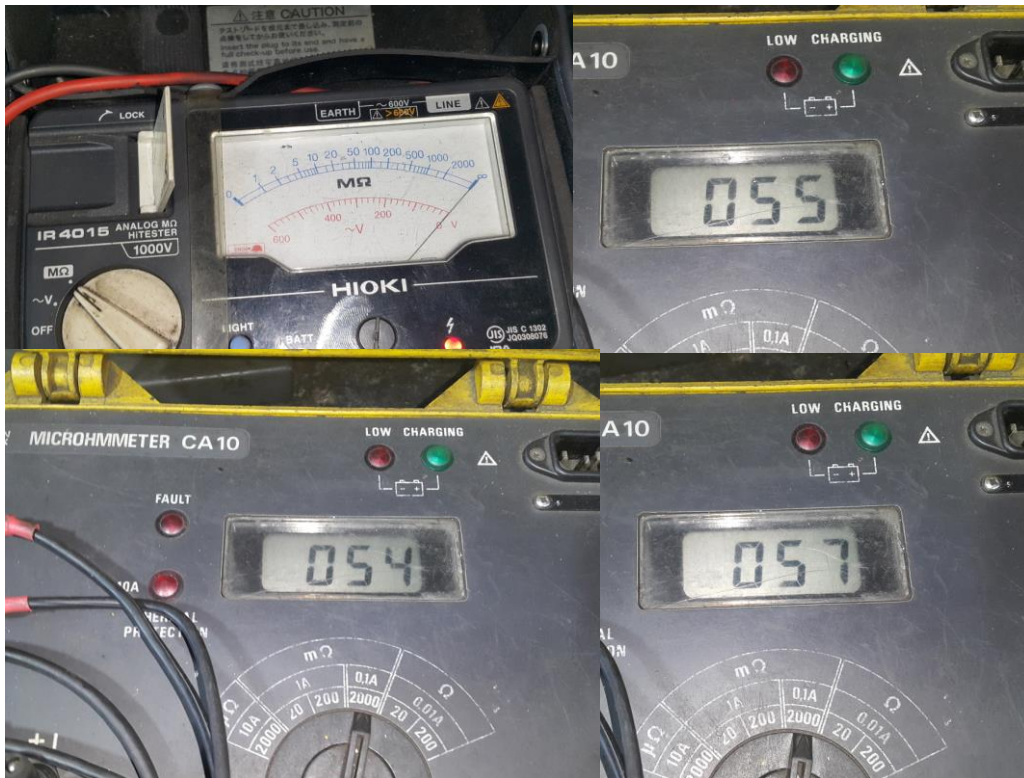

권선검사

절연저항 & 각상 LINE별 권선저항 동일

JIN YANG

작업 공정 사진

작업공정

AC MOTOR 100HP 2P 입고검사

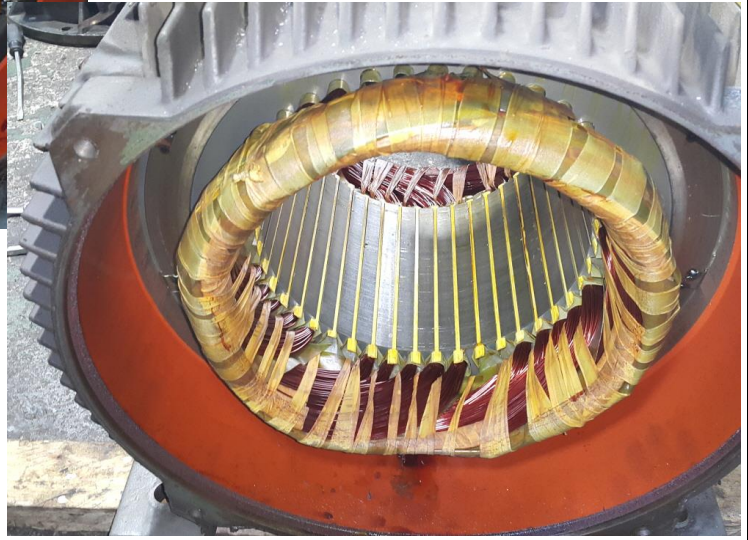
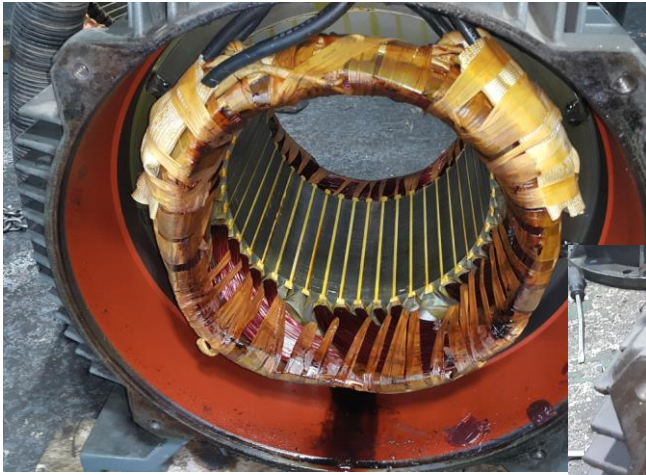

STATOR권체

권선상태 양호

작업공정

AC MOTOR 100HP 2P 입고검사



ROTOR

양호

JIN YANG

작업 공정 사진

작업공정

AC MOTOR 100HP 2P 입고검사



조립부품

양호

작업공정

AC MOTOR 100HP 2P 입고검사



BRACKET

부하측 HOUSING 검사 5/100로 불량

JIN YANG

작업 공정 사진

작업공정

AC MOTOR 100HP 2P OVERHAUL



BRACKET

반 부하측 HOUSING 검사 5/100로 불량

작업공정

AC MOTOR 100HP 2P OVERHAUL



STATOR권체

스팀세척 후 건조실시

JIN YANG

작업 공정 사진

작업공정

AC MOTOR 100HP 2P OVERHAUL



POWER CABLE

진동에 의한것으로 추정되는 CABLE 이상

작업공정

AC MOTOR 100HP 2P OVERHAUL

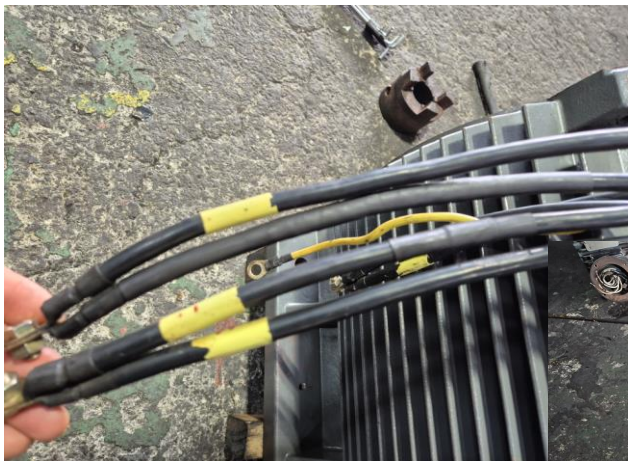

POWER CABLE

CABLE 보수 후 FLEXIBLE & CONNECTOR교환

JIN YANG

작업 공정 사진

작업공정

AC MOTOR 100HP 2P OVERHAUL



ROTOR

BALANCING 실시

작업공정

AC MOTOR 100HP 2P OVERHAUL





교정전



교정후

ROTOR

교정된 UNBALANCE REPORT참조

| | |
|--|--------------------------------------|
| JIN YANG | 작업 공정 사진 |
| 작업공정 | AC MOTOR 100HP 2P OVERHAUL |
|  | |
| 소모품 | 교환될 BEARING 예열 실시 |
| 작업공정 | AC MOTOR 100HP 2P OVERHAUL |
|  | |
| 소모품 | BEARING 예열교환 및 GREASE CHARGING 조립 실시 |

JIN YANG

작업 공정 사진

작업공정

AC MOTOR 100HP 2P OVERHAUL



BRACKET

양측 HOUSING METALLIZING 연마 후 검사 1/100

작업공정

AC MOTOR 100HP 2P OVERHAUL

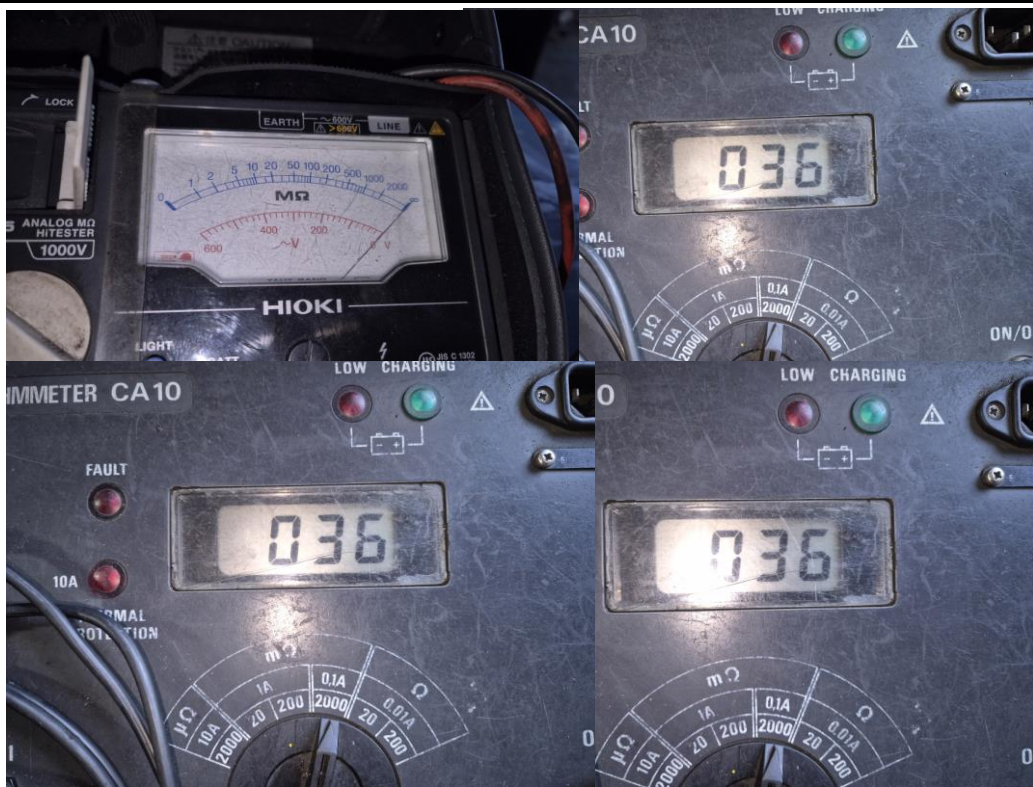

출고검사

절연저항 & 각 상 Δ 별 권선저항

JIN YANG

작업 공정 사진

작업공정

AC MOTOR 100HP 2P OVERHAUL

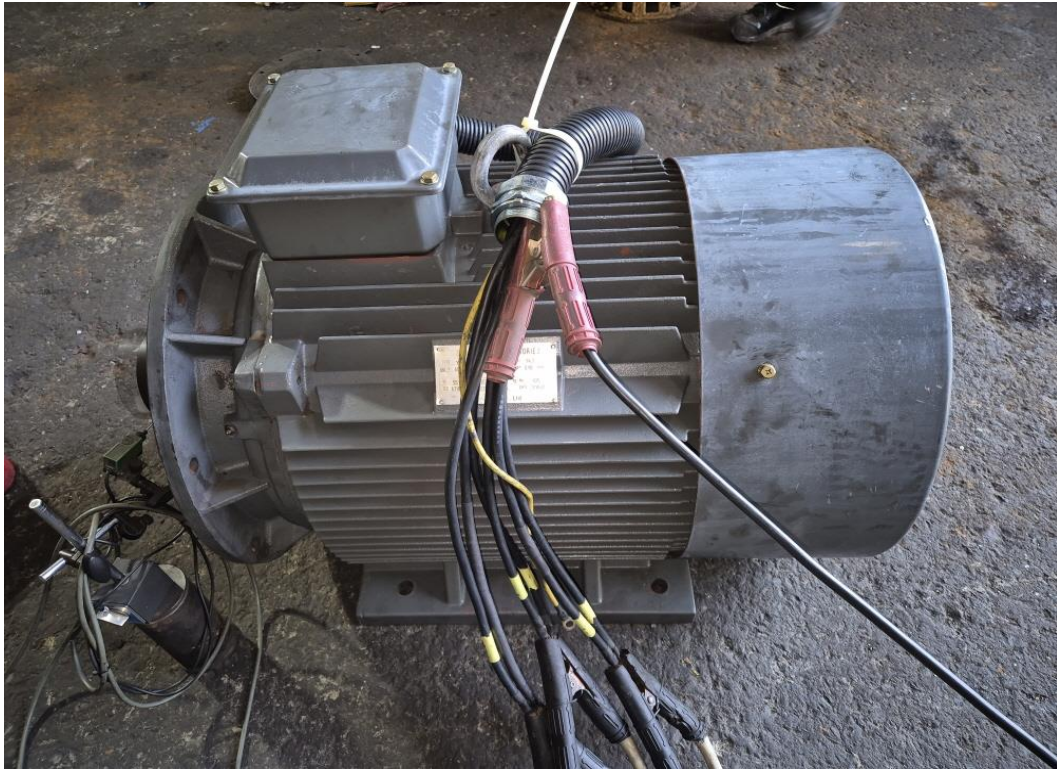

출고검사

시운전 TEST 실시

작업공정

AC MOTOR 100HP 2P OVERHAUL

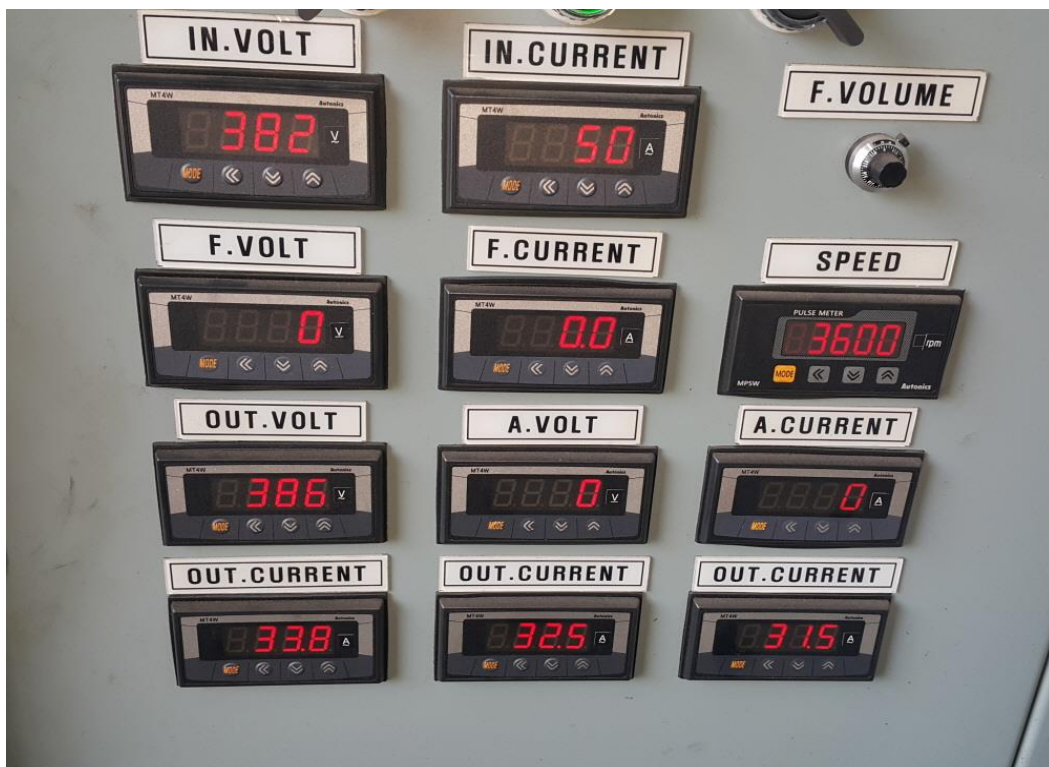

출고검사

시운전 TEST 운전 CURRENT

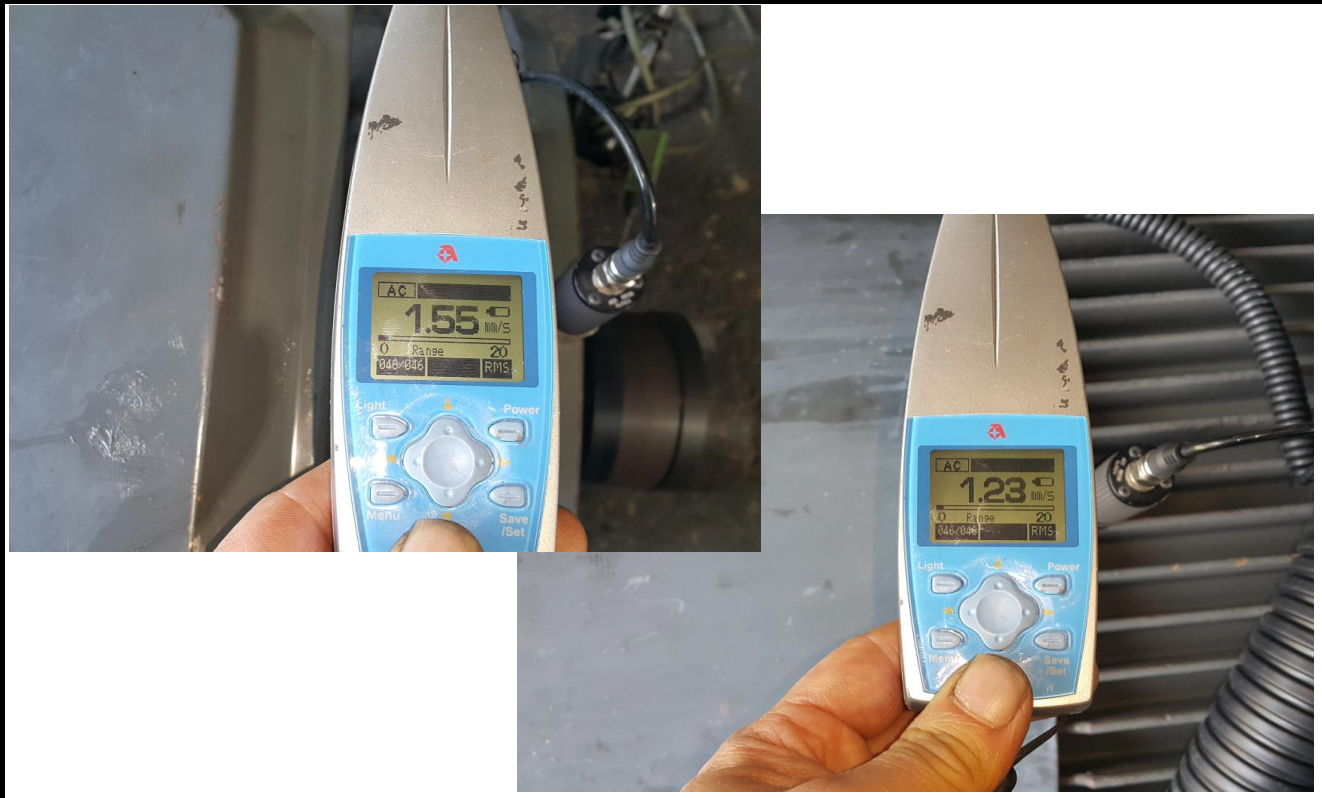
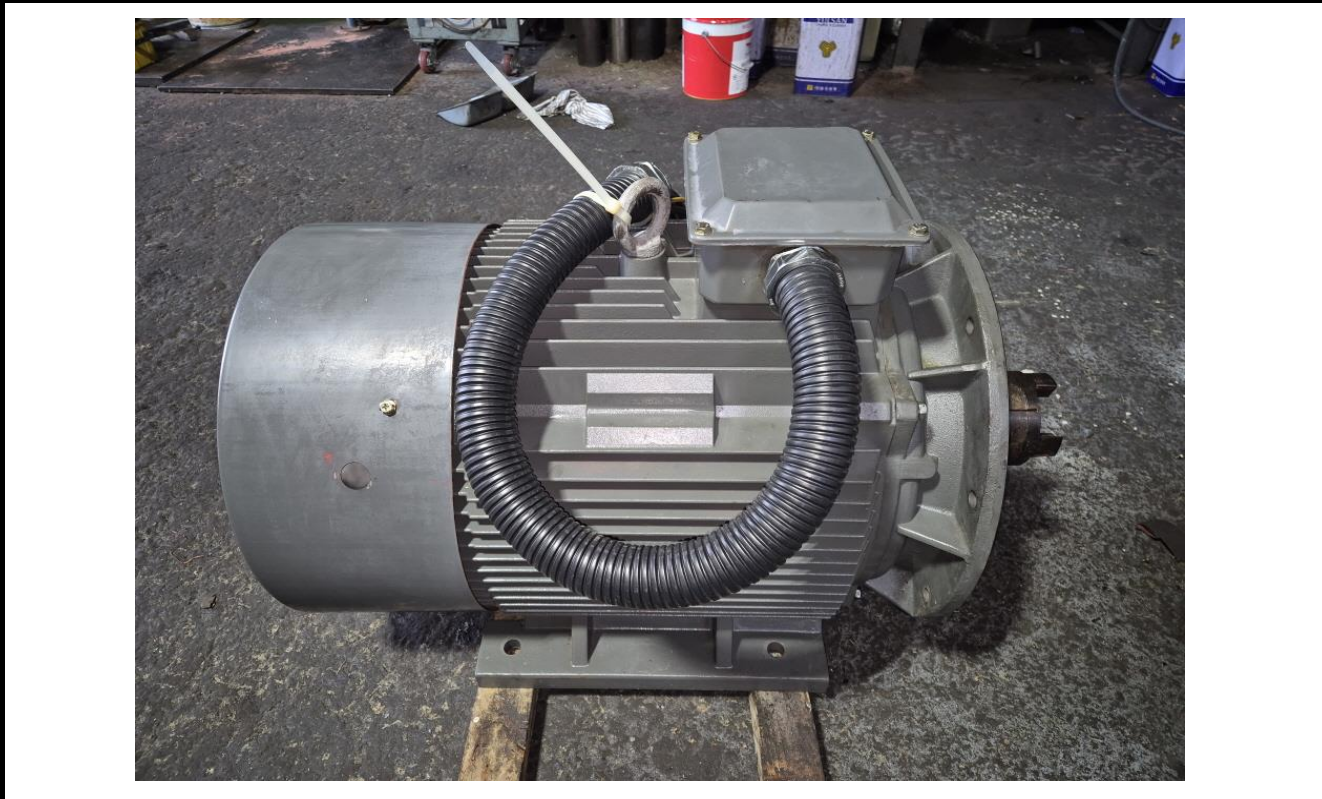
| | |
|--|----------------------------|
| JIN YANG | 작업 공정 사진 |
| 작업공정 | AC MOTOR 100HP 2P OVERHAUL |
|  | |
| 출고검사 | 진동검사 |
| 작업공정 | AC MOTOR 100HP 2P OVERHAUL |
|  | |
| Ass'y | 출고검사 후 |

BALANCING INSPECTION REPORT

SETUP

| | |
|------------------------------|---------------------------------|
| PROJECT NO: AIR COMP75KW 2P | |
| CUSTOMER : | |
| NO : | 0 |
| TYPE : | 0 |
| OPERATOR : | 0 |
| PART NAME : AC ROTOR | TEST TIME : 2026.04.16 09:25:05 |
| GRADE : G6.3 | RATING SPEED : 3600 rpm |
| WEIGHT : 114.000 kg | TESTING SPEED : 557 rpm |
| RADIUS : 83 mm 83 mm | CORRECTION : ADD |
| ACCEPTABLE UNBALANCE(Unit:g) | |
| PLANE1 : 11.500 | PLANE2 : 11.500 |

INITIAL UNBALANCE

| | PLANE1 | PLANE2 |
|-----------|----------|-----------|
| UNBALANCE | 69.100 g | 129.800 g |
| ANGLE | 214 deg | 41 deg |
| RESULT | NG | NG |

CORRECT UNBALANCE

| | PLANE1 | PLANE2 |
|-----------|---------|----------|
| UNBALANCE | 1.600 g | 10.600 g |
| ANGLE | 295 deg | 256 deg |
| RESULT | OK | OK |

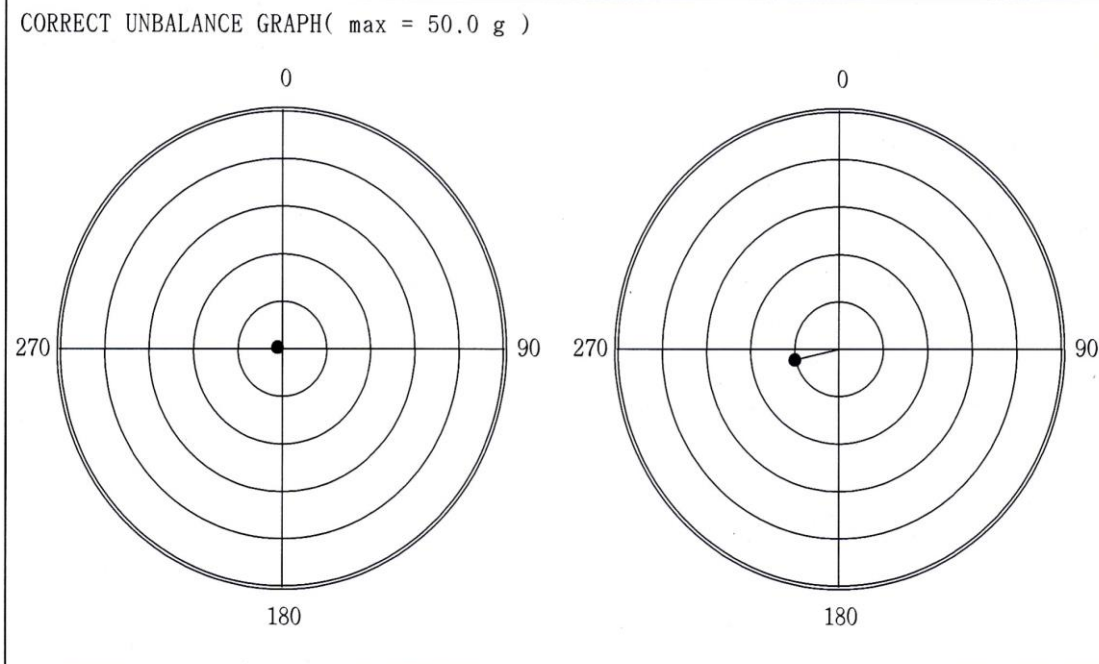

진양전기
 경남 창원시 마산회원구 내서읍 중리공단로3길 17-2
 TEL : 055-231-9318 FAX : 055-231-9314
 E-mail : jinyang2913@naver.com