

작업공정사진철

고객명:

공사명: DC MOTOR 예방정비

규격: DC MOTOR 380V 150KW 950~1500RPM

REPAIR 내역: 분해 조립 및 불순물 CLEANSING DRYING
INSULATING VARNISH DIPPING DRYING
반 부하측 BEARING SHAFT와 융합 가공 취외
반 부하측 BEARING부 METALLIZING 연마
부하측 HOUSING METALLIZING 연마
반 부하측 HOUSING -공차로 연마
COMMUTATOR 동심도 가공 및 UNDERCUTTING
BEARING 및 BRUSH 교환
출고검사 시운전 TEST 및 COLOR PAINTING



<http://jinyangmotor.com/>



JIN YANG

작업 공정 사진

작업공정

DC MOTOR 150KW 입고검사



Ass'y

분해 전

작업공정

DC MOTOR 150KW 입고검사

ARMATURE
절연저항



ARMATURE
권선저항

FIELD
절연저항



FIELD
권선저항

권선검사

절연저항 & 권선저항

JIN YANG

작업 공정 사진

작업공정

DC MOTOR 150KW 입고검사



반 부하측

BEARING 과열 융합으로 추정 예상됨

작업공정

DC MOTOR 150KW 입고검사



반 부하측

BEARING 과열 파손

JIN YANG	작업 공정 사진
----------	----------

작업공정	DC MOTOR 150KW 입고검사
------	---------------------



반 부하측	BEARING 과열 파손으로 SHAFT와 융합상태
-------	-----------------------------

작업공정	DC MOTOR 150KW 입고검사
------	---------------------



부하측 BEARING부	보아하니 주기적인 GREASE CHARGIN이 없었던 것으로 보여짐
--------------	---------------------------------------

매 주기500~1000시간마다 부하측 약150g 반후하100g식 GREASE CHARGIN을 권고 합니다

JIN YANG

작업 공정 사진

작업공정

DC MOTOR 150KW 입고검사



계자 권체

분해 후

작업공정

DC MOTOR 150KW 입고검사



계자 권체

BRUSH가루 등 불순물은 있으나 권선상태 양호

JIN YANG

작업 공정 사진

작업공정

DC MOTOR 150KW 입고검사



ARMATURE 권체

분해 후 권선상태 양호

작업공정

DC MOTOR 150KW 입고검사



COMMUTATOR

마모 및 조흔 현상

JIN YANG

작업 공정 사진

작업공정

DC MOTOR 150KW 입고검사



BRACKET

부하측 HOUSING 검사 16/100으로 불량

작업공정

DC MOTOR 150KW 입고검사





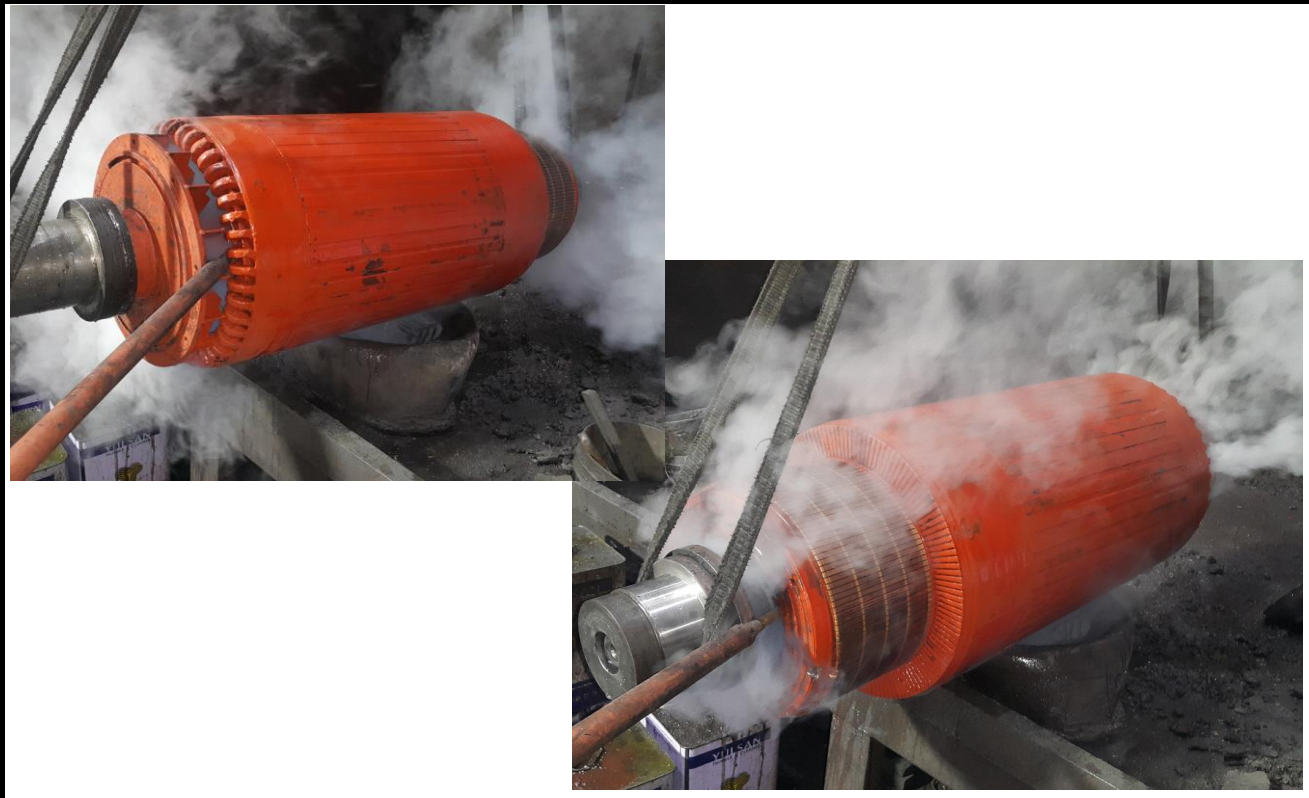
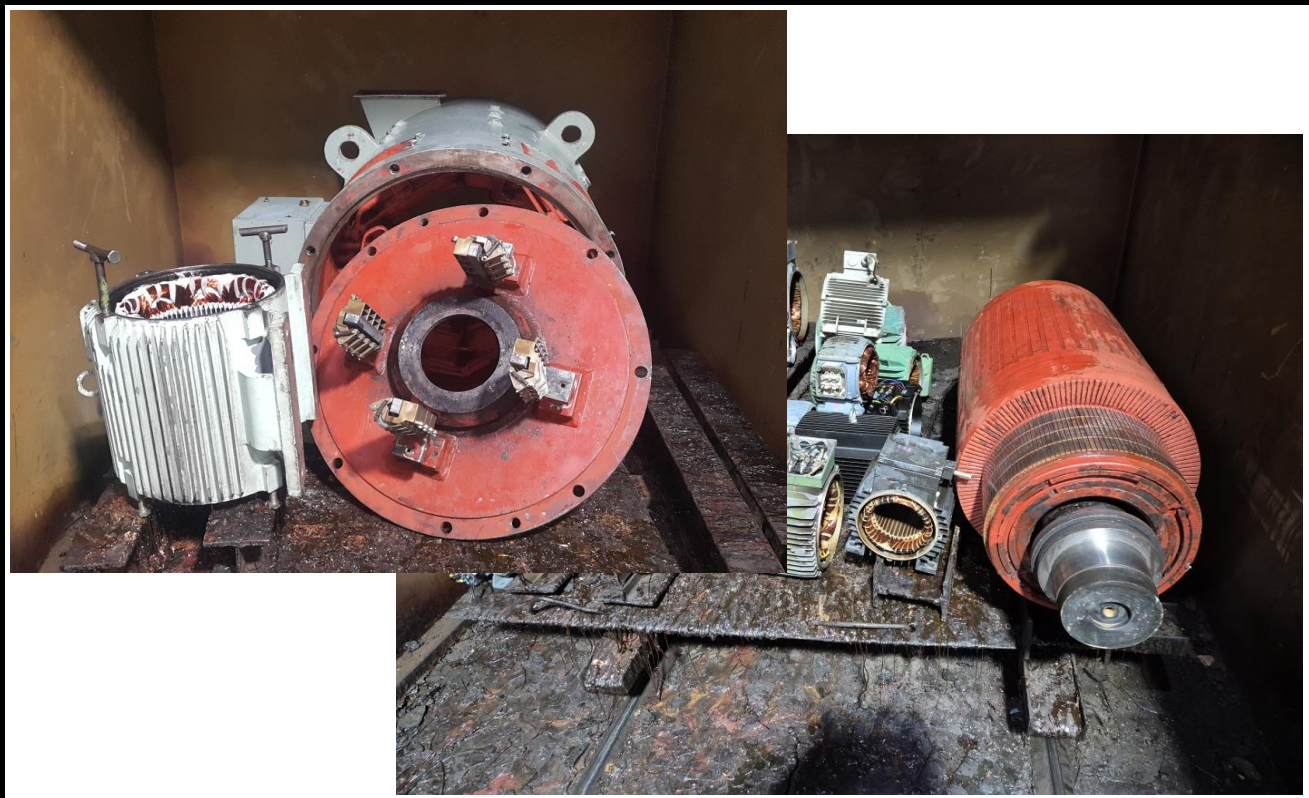

BRACKET

반 부하측 HOUSING 검사 -4~-9/100로 공차 수정이 필요

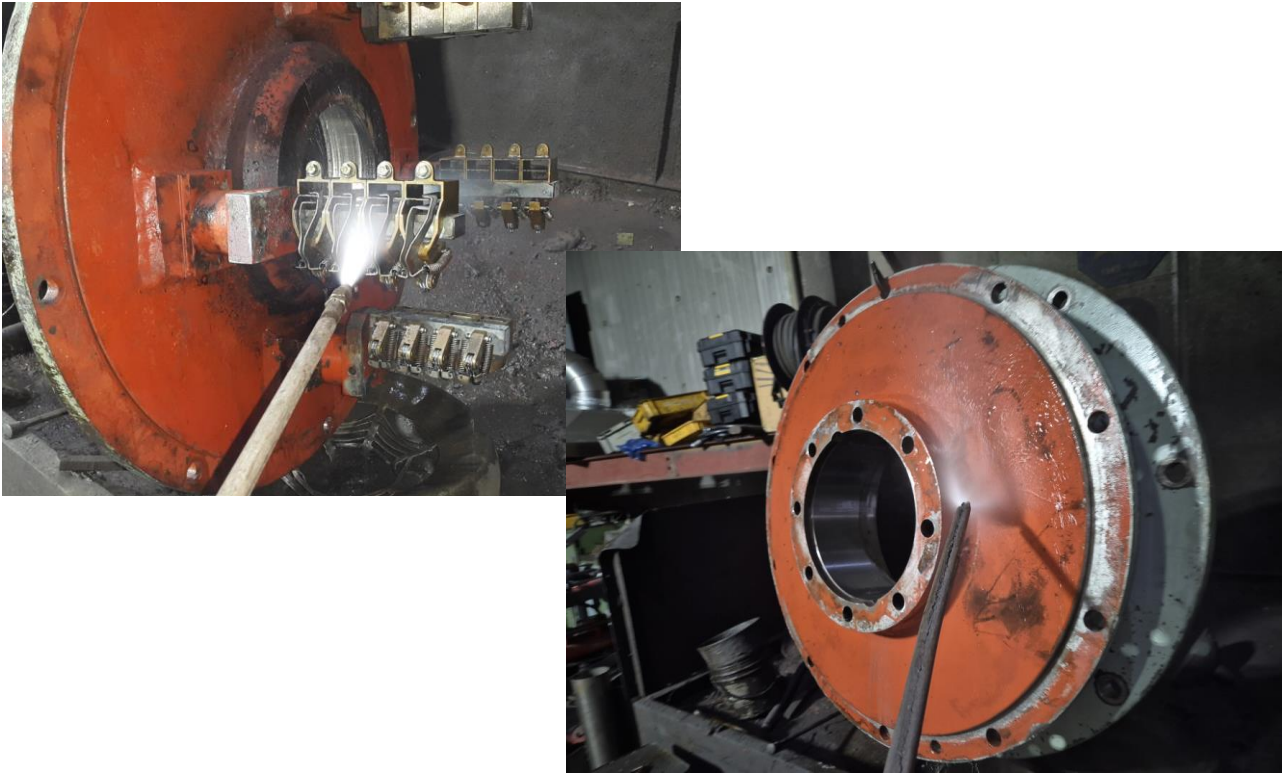
JIN YANG	작업 공정 사진
작업공정	DC MOTOR 150KW 입고검사
<div style="display: flex; justify-content: space-around;">  <div data-bbox="922 501 1394 539">BRUSH는 기름을 먹어 재 사용불사</div>  </div>	
소모품	BEARING & BRUSH 취외
작업공정	DC MOTOR 150KW OVERHAUL
<div style="display: flex; justify-content: space-around;">   </div>	
계자권체	스팀세척 실시

JIN YANG	작업 공정 사진
작업공정	DC MOTOR 150KW OVERHAUL
	
ARMATURE 권체	스팀세척 실시
작업공정	DC MOTOR 150KW OVERHAUL
	
권체	스팀세척 후 건조실시

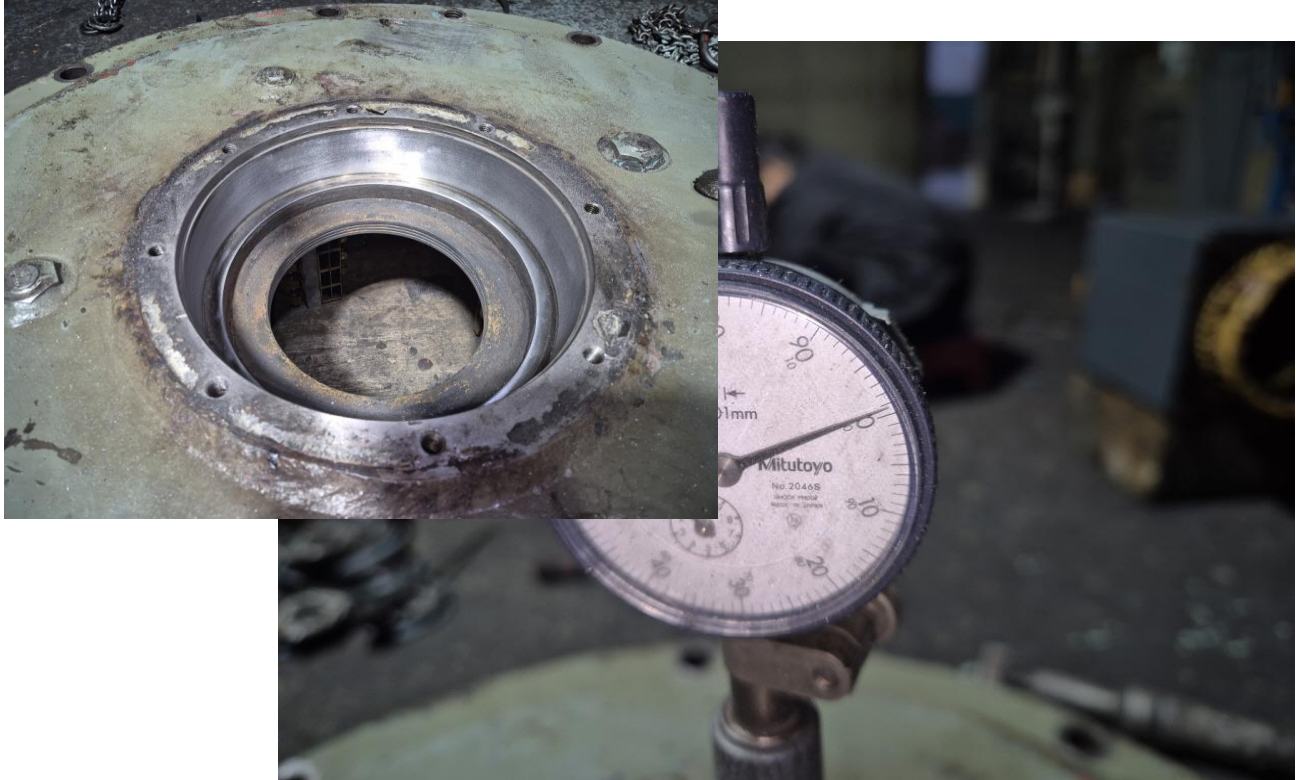
JIN YANG	작업 공정 사진
작업공정	DC MOTOR 150KW OVERHAUL
	
조립부품	세척 실시
작업공정	DC MOTOR 150KW OVERHAUL
	
BRACKET	부하측 HOUSING METALLIZING 연마 후 검사 0/100

JIN YANG	작업 공정 사진
작업공정	DC MOTOR 150KW OVERHAUL
	
BRACKET	반 부하측 HOUSING 연마 후 검사 1/100
작업공정	DC MOTOR 150KW OVERHAUL
	
반부하 측	BEARING부 SHAFT METALLIZING 연마 후 검사 2/100

JIN YANG

작업 공정 사진

작업공정

DC MOTOR 150KW OVERHAUL



COMMUTATOR

동심도 가공 홈파기 및 UNDERCUTTING 실시 후

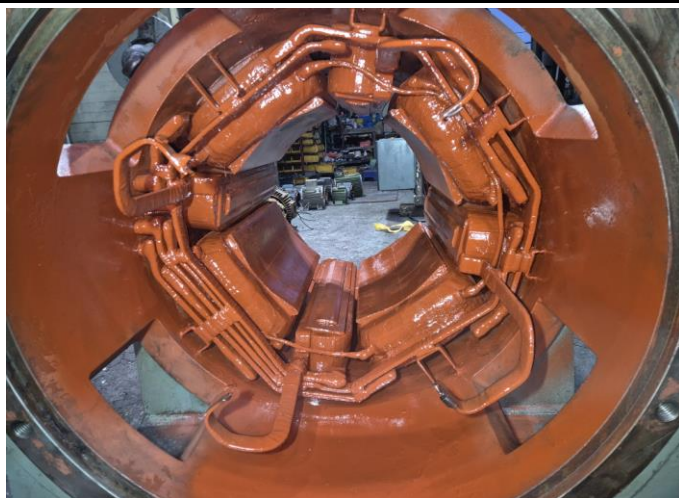

작업공정

DC MOTOR 150KW OVERHAUL



권체

URETHANE MODIFIED ACRYLIC COATING 실시

JIN YANG	작업 공정 사진
작업공정	DC MOTOR 150KW OVERHAUL
	
소모품	교환될 BEARING & BRUSH
작업공정	DC MOTOR 150KW OVERHAUL
 <p data-bbox="156 1720 248 1756">부하측</p>	 <p data-bbox="1315 1720 1407 1756">반부하측</p>
소모품	BEARING 예열교환 및 GREASE CHARGING 조립실시

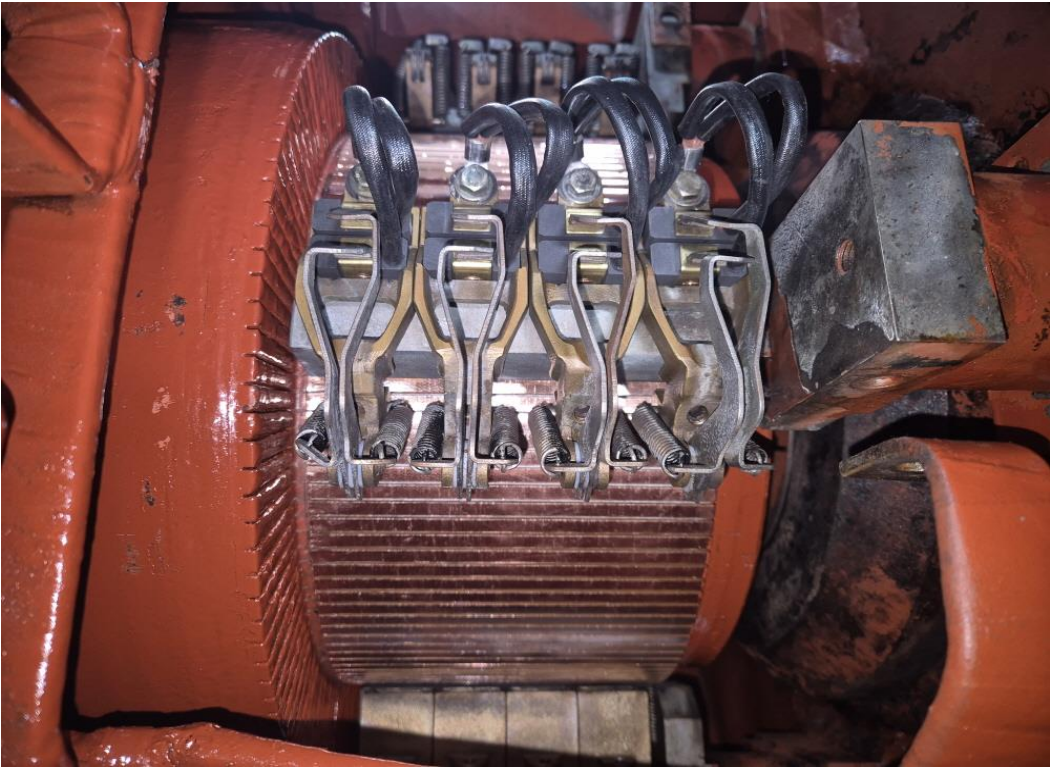
JIN YANG	작업 공정 사진
작업공정	DC MOTOR 150KW OVERHAUL
	
양측	GREASE CHARGING구 설치
작업공정	DC MOTOR 150KW OVERHAUL
	
소모품	BRUSH 교환

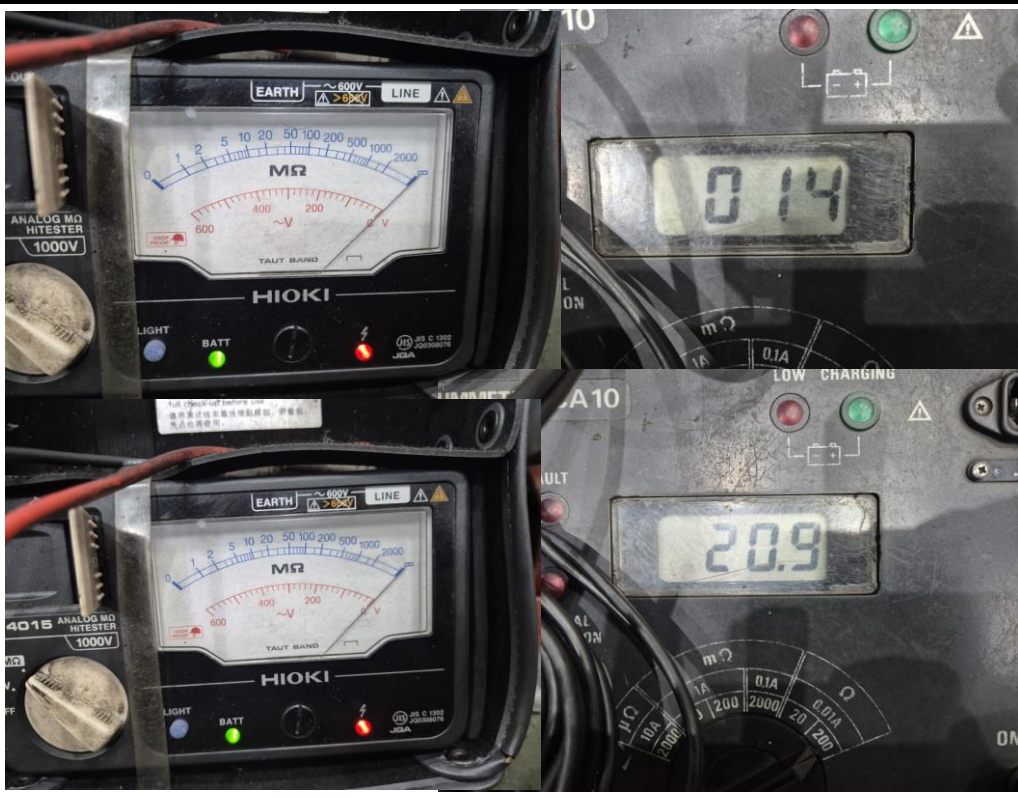
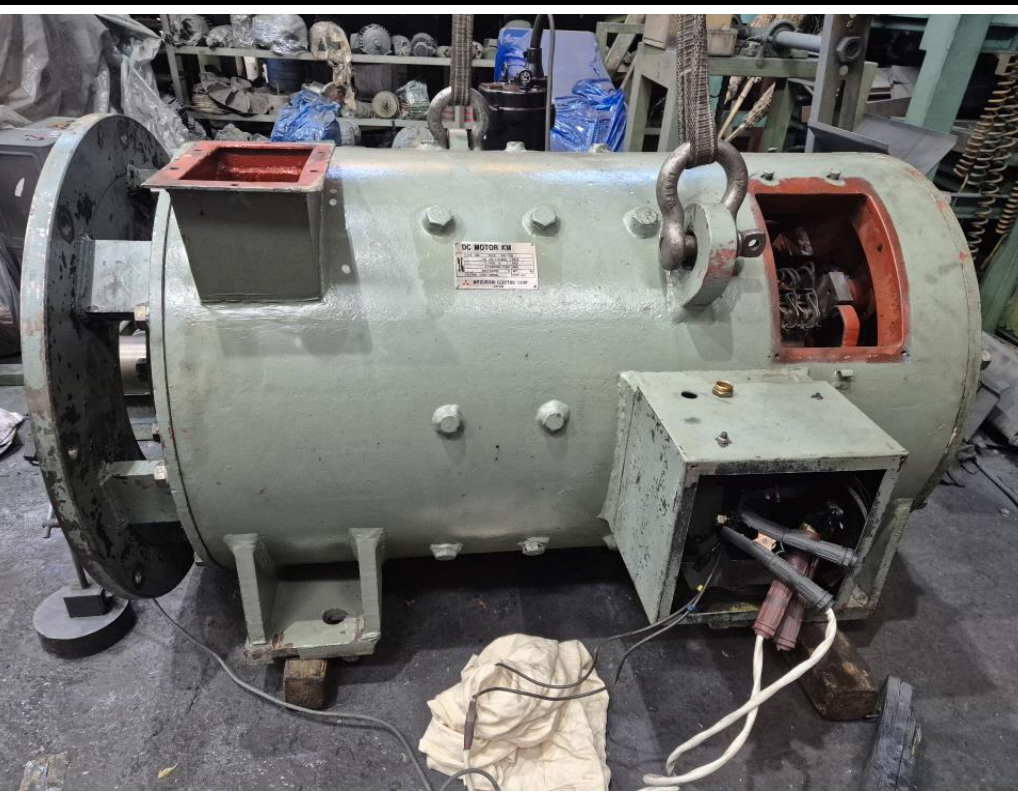
JIN YANG	작업 공정 사진
작업공정	DC MOTOR 150KW OVERHAUL
<p>ARMATURE 절연저항</p> <p>FIELD 절연저항</p>	 <p>ARMATURE 권선저항</p> <p>FIELD 권선저항</p>
출고검사	절연저항 & 권선저항
작업공정	DC MOTOR 150KW OVERHAUL
	
출고검사	시운전 TEST실시

JIN YANG

작업 공정 사진

작업공정

DC MOTOR 150KW OVERHAUL



출고검사

시운전 TEST 실시 운전 CURRENT

작업공정

DC MOTOR 150KW OVERHAUL



Ass'y

출고검사 후