

작업공정사진철

고객명:

공사명: SUBMERSIBLE PUMP MOTOR 예방정비

규격: PUMP MOTOR 380V 60HP 6P

REPAIR 내역: 분해 조립 및 조립부품 불순물 CLEANSING
INSULATING VARNISH DIPPING DRYING
BALANCING 및 UNBALANCE교정
고압력 MECHANICAL SEAL교환
BEARING 및 가타 소모품 교환
입 출고검사 시운전 TEST 및 COLOR PAINTING



<http://jinyangmotor.com/>



JIN YANG

작업 공정 사진

작업공정

수중 PUMP MOTOR 60HP 4P 입고검사



Ass'y

분해 전

작업공정

수중 PUMP MOTOR 60HP 4P 입고검사



권선검사

절연저항 & 각상 LINE별 권선저항

JIN YANG

작업 공정 사진

작업공정

수중 PUMP MOTOR 60HP 4P 입고검사



분해 전

외부 녹이 썰러 부식이 많은 상태

작업공정

수중 PUMP MOTOR 60HP 4P 입고검사



분해 전

외부 녹 제거 및 불순물 세척실시

JIN YANG

작업 공정 사진

작업공정

수중 PUMP MOTOR 60HP 4P 입고검사



분해 실시

STAND & WATER CHAMBER SEAL COVER 부식이 많은 상태

작업공정

수중 PUMP MOTOR 60HP 4P 입고검사



분해 실시

OIL CHAMBER & WATER CHAMBER 노출 부

JIN YANG

작업 공정 사진

작업공정

수중 PUMP MOTOR 60HP 4P 입고검사



분해 실시

WATER CHAMBER SEAL ADAPTER 산화 현상

작업공정

수중 PUMP MOTOR 60HP 4P 입고검사



OIL CHAMBER

물 유입 있었습

JIN YANG

작업 공정 사진

작업공정

수중 PUMP MOTOR 60HP 4P 입고검사



제작사가 불명확하여 부식된 부품구매가 안됨으로 인해 추후 정비가 불가할 것으로 판단됨

작업공정

수중 PUMP MOTOR 60HP 4P 입고검사

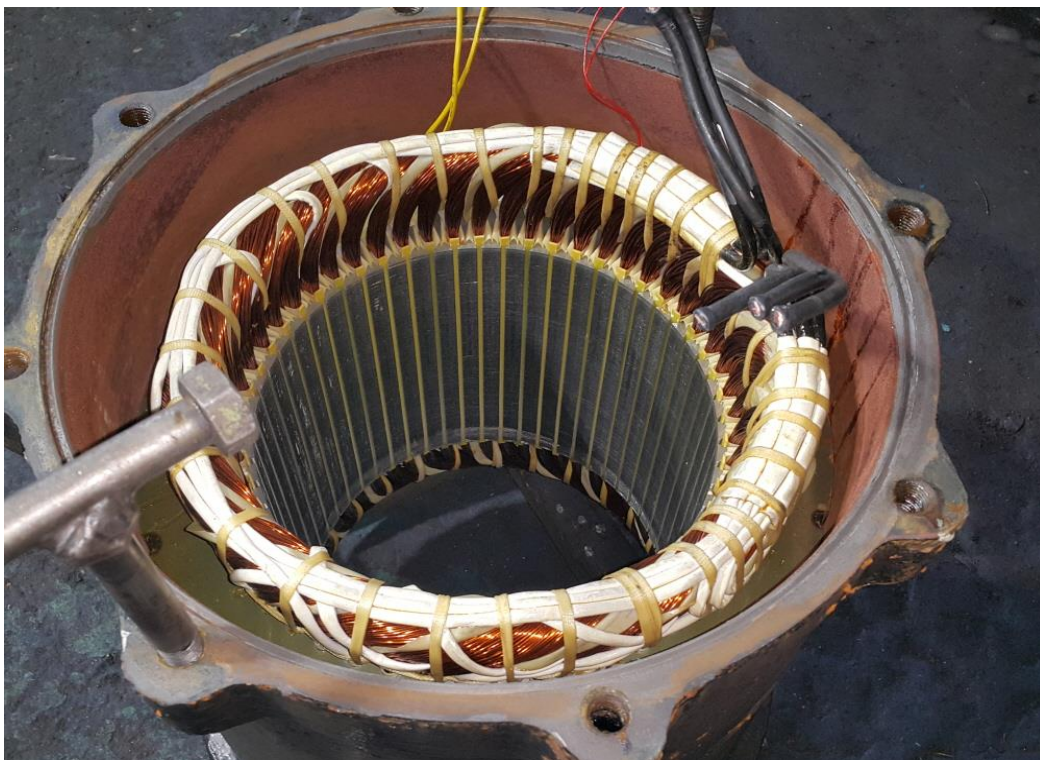

STATOR권체

권선상태 양호

JIN YANG	작업 공정 사진
----------	----------

작업공정	수중 PUMP MOTOR 60HP 4P 입고검사
------	----------------------------



조립부품	HOUSING검사 양호
------	--------------

작업공정	수중 PUMP MOTOR 60HP 4P OVERHAUL
------	--------------------------------



STATOR권체	세척 후 절연건조 실시
----------	--------------

JIN YANG

작업 공정 사진

작업공정

수중 PUMP MOTOR 60HP 4P OVERHAUL

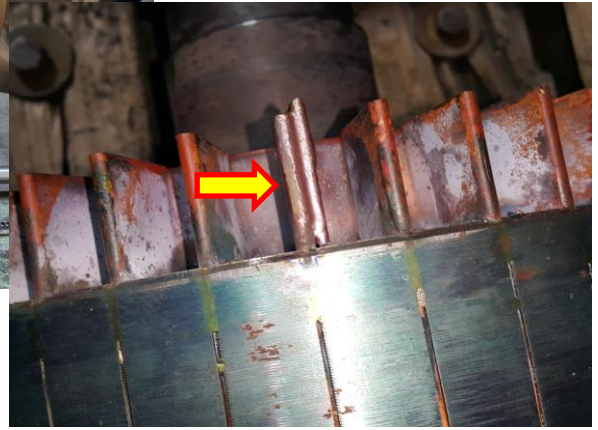
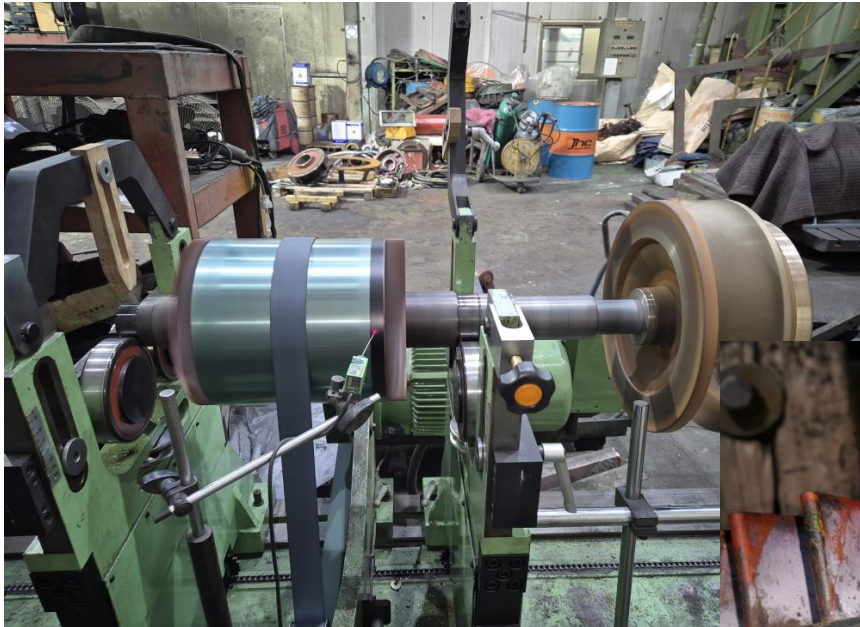

ROTOR & IMPELLER

BALANCING 실시 및 교정된 UNBALANCE REPORT 참조

작업공정

수중 PUMP MOTOR 60HP 4P OVERHAUL



조립부품

MECHANICAL SEAL 및 ADAPTER의 부품

JIN YANG	작업 공정 사진
----------	----------

작업공정	수중 PUMP MOTOR 60HP 4P OVERHAUL
------	--------------------------------

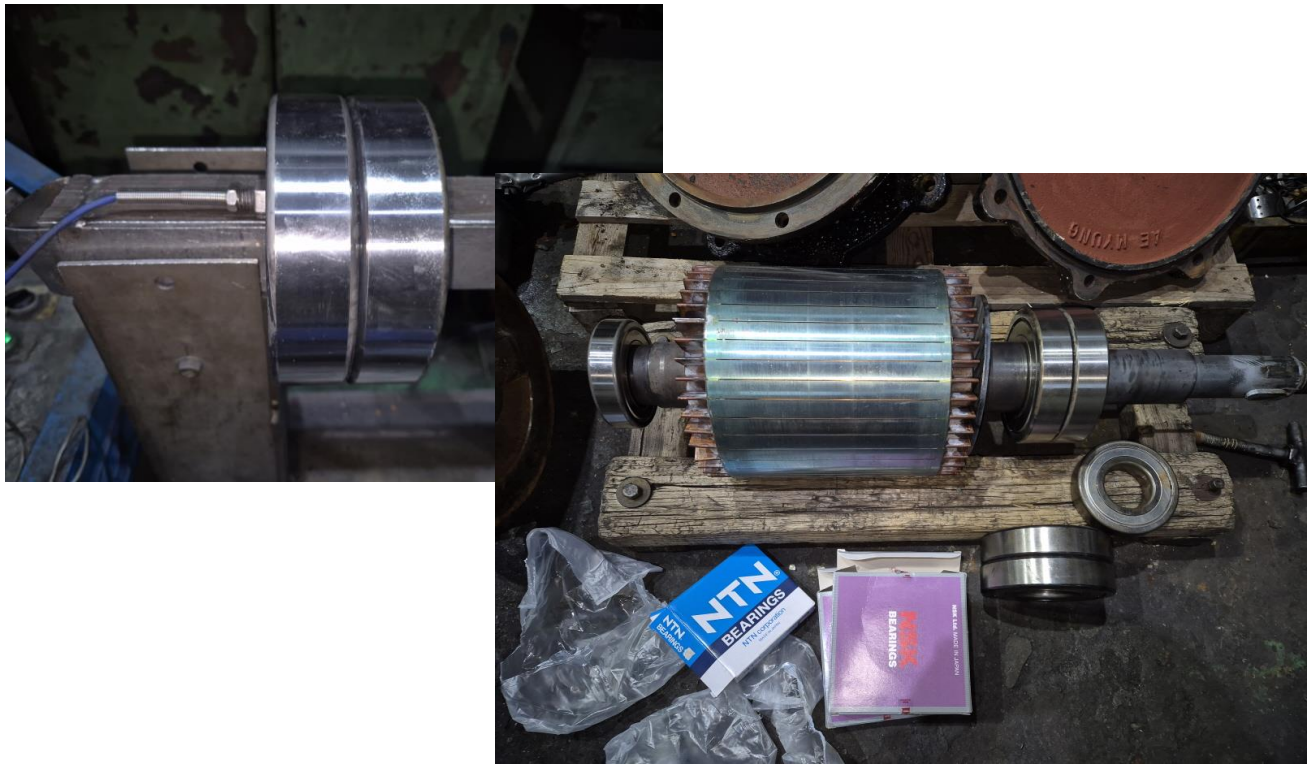



ROTOR	BEARING 예열교환 실시
-------	-----------------

작업공정	수중 PUMP MOTOR 60HP 4P OVERHAUL
------	--------------------------------



소모 부품	고압력 MECHANICAL SEAL 조립실시
-------	--------------------------

JIN YANG	작업 공정 사진
작업공정	수중 PUMP MOTOR 60HP 4P OVERHAUL
	
조립	WATER CHAMBER SEAL & ADAPTER 교환 조립실시
작업공정	수중 PUMP MOTOR 60HP 4P OVERHAUL
	
출고검사	절연저항 & 각상 Δ시 권선저항

JIN YANG

작업 공정 사진

작업공정

수중 PUMP MOTOR 60HP 4P OVERHAUL

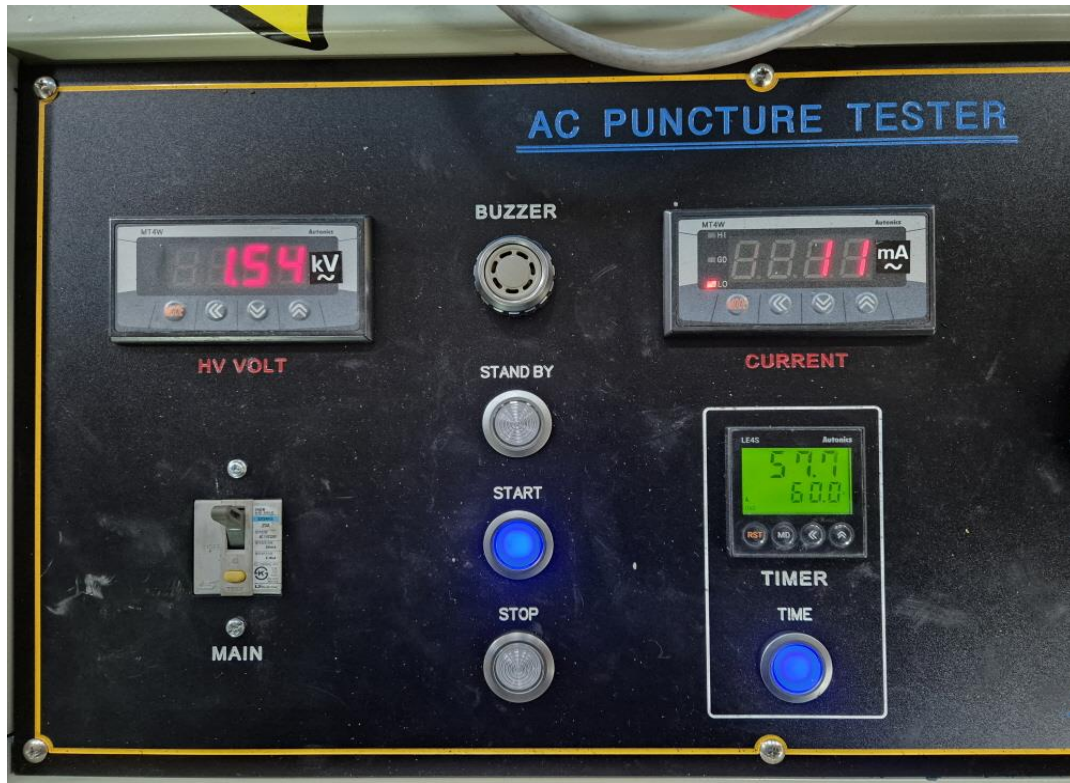

출고검사

절연내력 시험

작업공정

수중 PUMP MOTOR 60HP 4P OVERHAUL



출고검사

시운전 TEST 실시

JIN YANG

작업 공정 사진

작업공정

수중 PUMP MOTOR 60HP 4P OVERHAUL



출고검사

시운전 TEST △운전 CURRENT

작업공정

수중 PUMP MOTOR 60HP 4P OVERHAUL



부하측



반부하측

출고검사

진동검사

JIN YANG

작업 공정 사진

작업공정

수중 PUMP MOTOR 60HP 4P OVERHAUL



출고검사

소음검사

작업공정

수중 PUMP MOTOR 60HP 4P OVERHAUL



출고검사 후

COLOR PAINTING

BALANCING INSPECTION REPORT

SETUP

PROJECT NO: 수중 PUMO MOTOR 45KW6P	
CUSTOMER : NO : 0 TYPE : 0 OPERATOR : 0	
PART NAME : AC ROTOR	TEST TIME : 2025.12.02 15:14:43
GRADE : G6.3	RATING SPEED : 1200 rpm
WEIGHT : 152.000 kg	TESTING SPEED : 527 rpm
RADIUS : 100 mm 150 mm	CORRECTION : ADD
ACCEPTABLE UNBALANCE(Unit:g)	
PLANE1 : 38.100	PLANE2 : 25.400

INITIAL UNBALANCE

	PLANE1	PLANE2
UNBALANCE	31.100 g	19.500 g
ANGLE	85 deg	274 deg
RESULT	OK	OK

CORRECT UNBALANCE

	PLANE1	PLANE2
UNBALANCE	3.400 g	19.400 g
ANGLE	88 deg	274 deg
RESULT	OK	OK

CORRECT UNBALANCE GRAPH(max = 50.0 g)

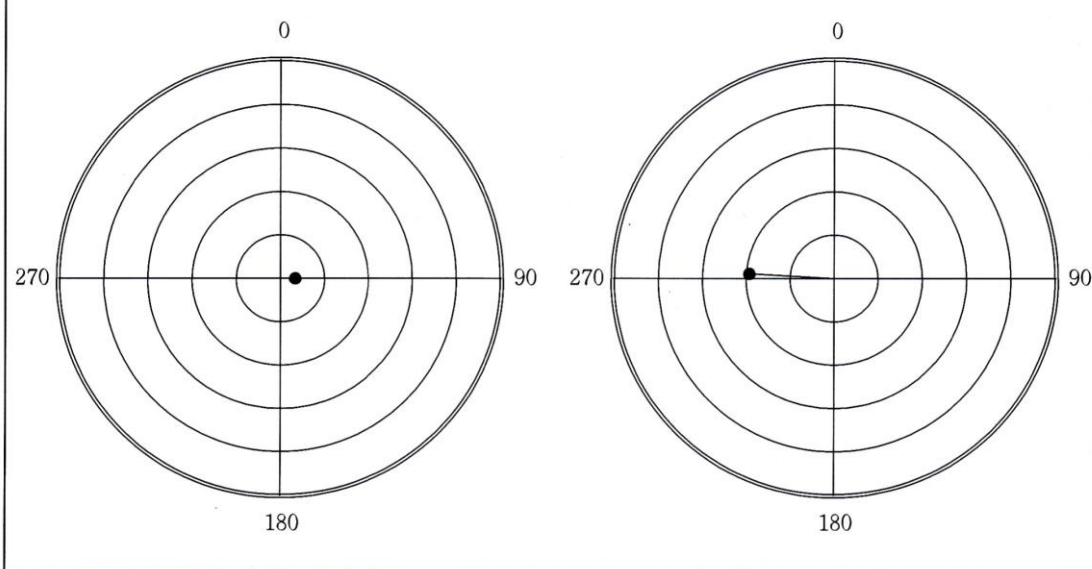

진양전기
 경남 창원시 마산회원구 내서읍 중리공단로3길 17-2
 TEL : 055-231-9318 FAX : 055-231-9314
 E-mail : jinyang2913@naver.com