

작업공정사진철

고객명: (주)
공사명: 단조 170MN PEES MAIN MOTOR

규격: AC MOTOR 6600V 800KW 4P

REPAIR 내역: 분해 조립 및 조립부품 불순물 CLEANSING
INSULATING VARNISH DIPPING DRYING
BALANCING 및 UNBALANCE교정
양측 HOUSING METALLIZING 연마
BEARING 교환
입 출고검사 시운전 TEST 및 COLOR PAINTING



<http://jinyangmotor.com/>



JIN YANG

작업 공정 사진

작업공정

AC MOTOR 800KW 4P 입고검사



Ass'y

분해 전

작업공정

AC MOTOR 800KW 4P 입고검사



권선 검사

절연저항 & 각 상별 권선저항

JIN YANG

작업 공정 사진

작업공정

AC MOTOR 800KW 4P 입고검사



Ass'y

외부 기름띠 세척 후 분해실시

작업공정

AC MOTOR 800KW 4P 입고검사







반부하





부하측

분해 실시

BEARING부

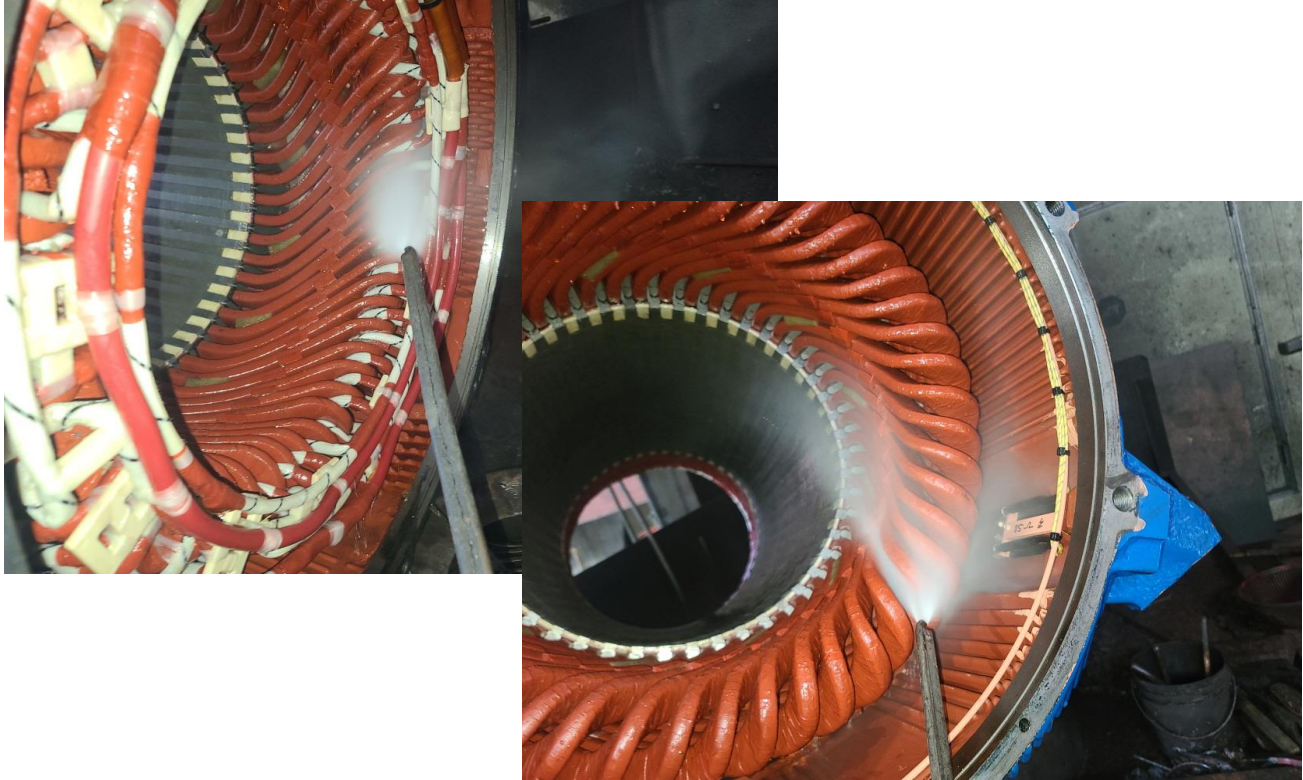
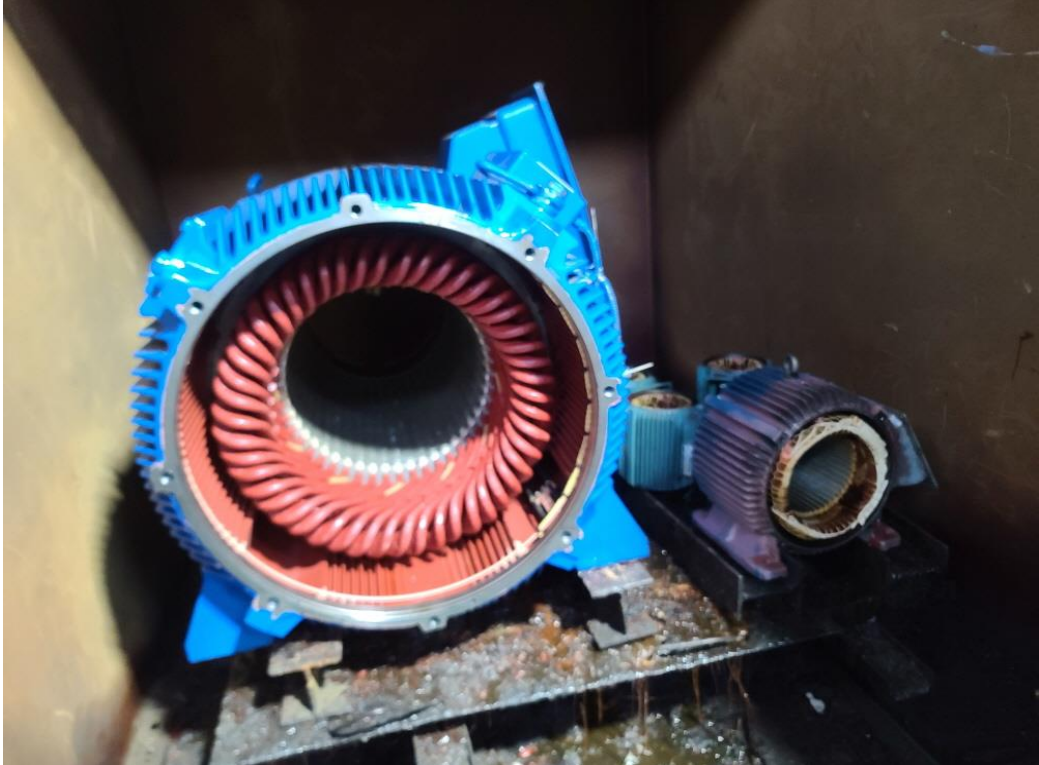
| | |
|---|--|
| JIN YANG | 작업 공정 사진 |
| 작업공정 | AC MOTOR 800KW 4P 입고검사 |
|  |  |
| BRACKET | 부하측 HOUSING 측정치 5/100으로 불량 |
| 작업공정 | AC MOTOR 800KW 4P 입고검사 |
|  |  |
| BRACKET | 반 부하측 HOUSING 측정치 8/100으로 불량 |

| | |
|--|----------------------------|
| JIN YANG | 작업 공정 사진 |
| 작업공정 | AC MOTOR 800KW 4P OVERHAUL |
|  | |
| STATOR권체 | 세척 실시 |
| 작업공정 | AC MOTOR 800KW 4P OVERHAUL |
|  | |
| STATOR권체 | 세척 후 건조 실시 |

| | |
|--|-----------------------------|
| JIN YANG | 작업 공정 사진 |
| 작업공정 | AC MOTOR 800KW 4P OVERHAUL |
|  | |
| BRACKET | 부하측 HOUSING 보수 후 검사 1/100 |
| 작업공정 | AC MOTOR 800KW 4P OVERHAUL |
|  | |
| BRACKET | 반 부하측 HOUSING 보수 후 검사 1/100 |

JIN YANG

작업 공정 사진

작업공정

AC MOTOR 800KW 4P OVERHAUL

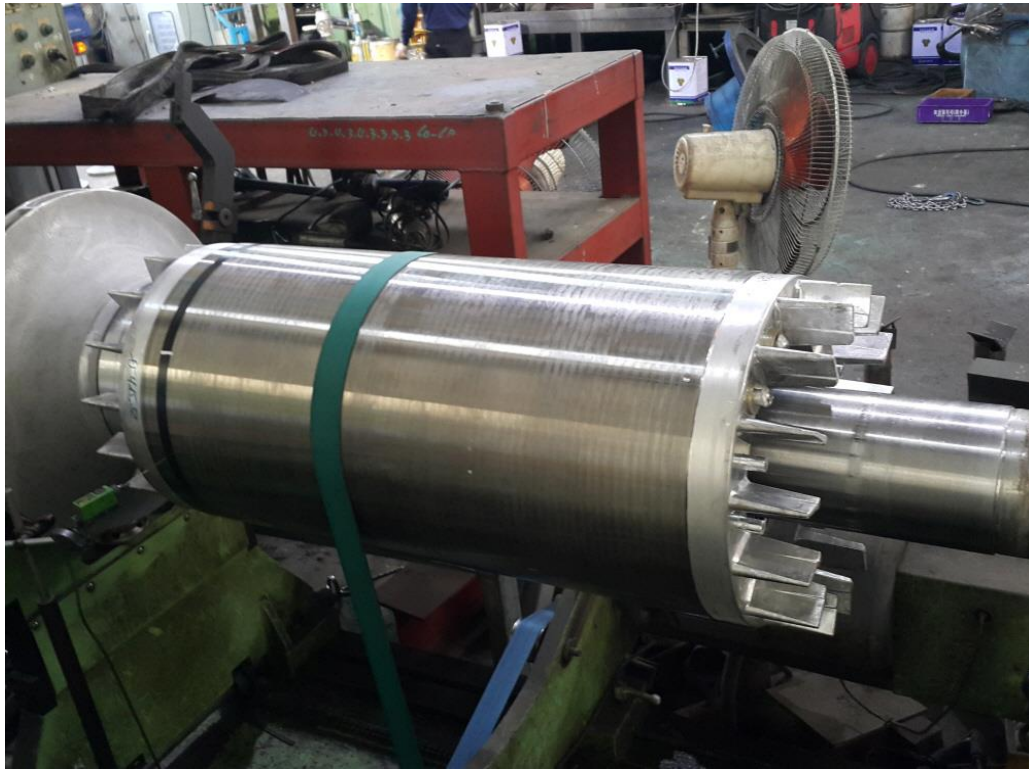

ROTOR

BALANCING 실시

작업공정

AC MOTOR 800KW 4P OVERHAUL



소모 품

교환될 신규 BEARING 예열 실시

JIN YANG

작업 공정 사진

작업공정

AC MOTOR 800KW 4P OVERHAUL



소모 품

BEARING 예열 삽입 및 GREASE CHARGING 실시

그 주기는 1200~1500시간 주기마다 약70~80g씩 하십시오

작업공정

AC MOTOR 800KW 4P OVERHAUL



출고검사

절연저항 & 각 상별 권선저항

JIN YANG

작업 공정 사진

작업공정

AC MOTOR 800KW 4P OVERHAUL



출고검사

절연내력 시험

작업공정

AC MOTOR 800KW 4P OVERHAUL



출고검사

시운전 TEST 실시

당사 전력 사정상 751V로 RUNNING TEST만 실시함

<http://jinyangmotor.com/>

JIN YANG

작업 공정 사진

작업공정

AC MOTOR 800KW 4P OVERHAUL



출고검사

시운전 TEST 운전 CURRENT

작업공정

AC MOTOR 800KW 4P OVERHAUL



Ass'y

출고검사 후

BALANCING INSPECTION REPORT

SETUP

| | | | |
|--------------------------------|------------|-----------------|----------|
| PART NAME : AC ROTOR 4P | | | |
| CUSTOMER : | | | |
| TEST TIME : 2023. 3.15 8:55:56 | | | |
| GRADE : | G 6.3 | RATING SPEED : | 1800 rpm |
| WEIGHT : | 820.000 kg | TESTING SPEED : | 532 rpm |
| DIAMETER : | 410 mm | CORRECTION : | ADD |
| ACCEPTABLE UNBALANCE | | | |
| PLANE1 : | 66.9 gr | PLANE2 : | 66.9 gr |

INITIAL UNBALANCE

| | PLANE1 | PLANE2 |
|-----------|---------|---------|
| UNBALANCE | 24.1 gr | 21.7 gr |
| ANGLE | 160 deg | 39 deg |
| RESULT | ACCEPT | ACCEPT |

CORRECT UNBALANCE

| | PLANE1 | PLANE2 |
|-----------|---------|---------|
| UNBALANCE | 24.1 gr | 21.7 gr |
| ANGLE | 160 deg | 39 deg |
| RESULT | ACCEPT | ACCEPT |

CORRECT UNBALANCE GRAPH (max = 50.0 gr)

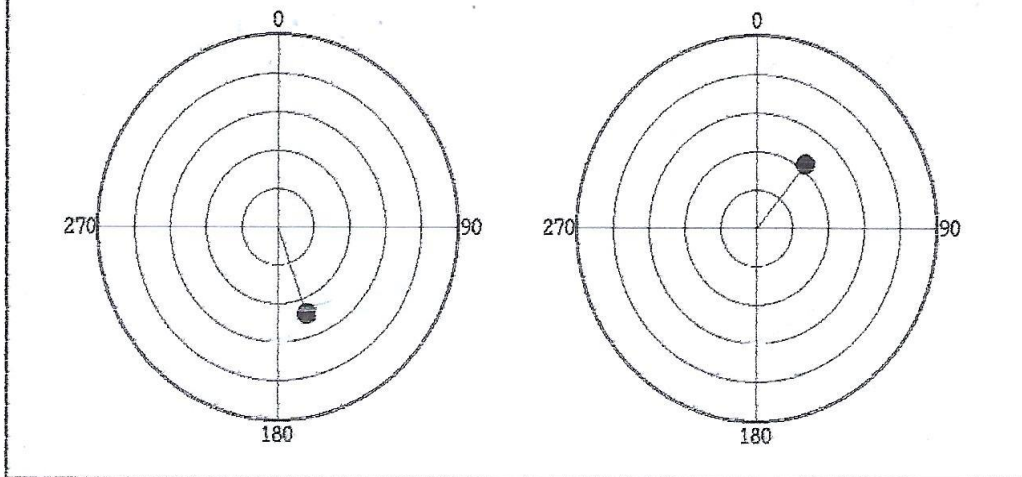

진양전기

경남 마산시 내서읍 중리 1123-3번지

TEL (055) - 231-9318-9

FAX (055) - 231-9314