

작업공정사진철

고객명: (주) 삼척사업소

공사명: AC MOTOR REWINDING

규격: AC MOTOR 200KW 4P 440V

REPAIR 내역: 분해 조립 및 조립부품 불순물 CLEANSING
STATOR REWINDING
INSULATING VARNISH DIPPING DRYING
BALANCING 및 UNBALANCE교정
부하측 HOUSING METALLIZING 연마
BEARING 교환
입 출고검사 시운전 TEST 및 COLOR PAINTING



<http://jinyangmotor.com/>



JIN YANG

작업 공정 사진

작업공정

AC MOTOR 200KW 4P 입고검사



Ass'y

분해 전

작업공정

AC MOTOR 200KW 4P 입고검사



권선 검사

절연저항 이상 & 각 상별 권선저항 5%이내일때 양호

JIN YANG

작업 공정 사진

작업공정

AC MOTOR 200KW 4P 입고검사



외관검사

FAN COVER 녹 제거

작업공정

AC MOTOR 200KW 4P 입고검사



STATOR 권선

분해 후 권선 소손 부

습도나 물 유입으로 절연파괴 소손 된 것으로 짐작 됩니다

JIN YANG	작업 공정 사진
작업공정	AC MOTOR 200KW 4P 입고검사



소모품	BEARING교환
작업공정	AC MOTOR 200KW 4P 입고검사

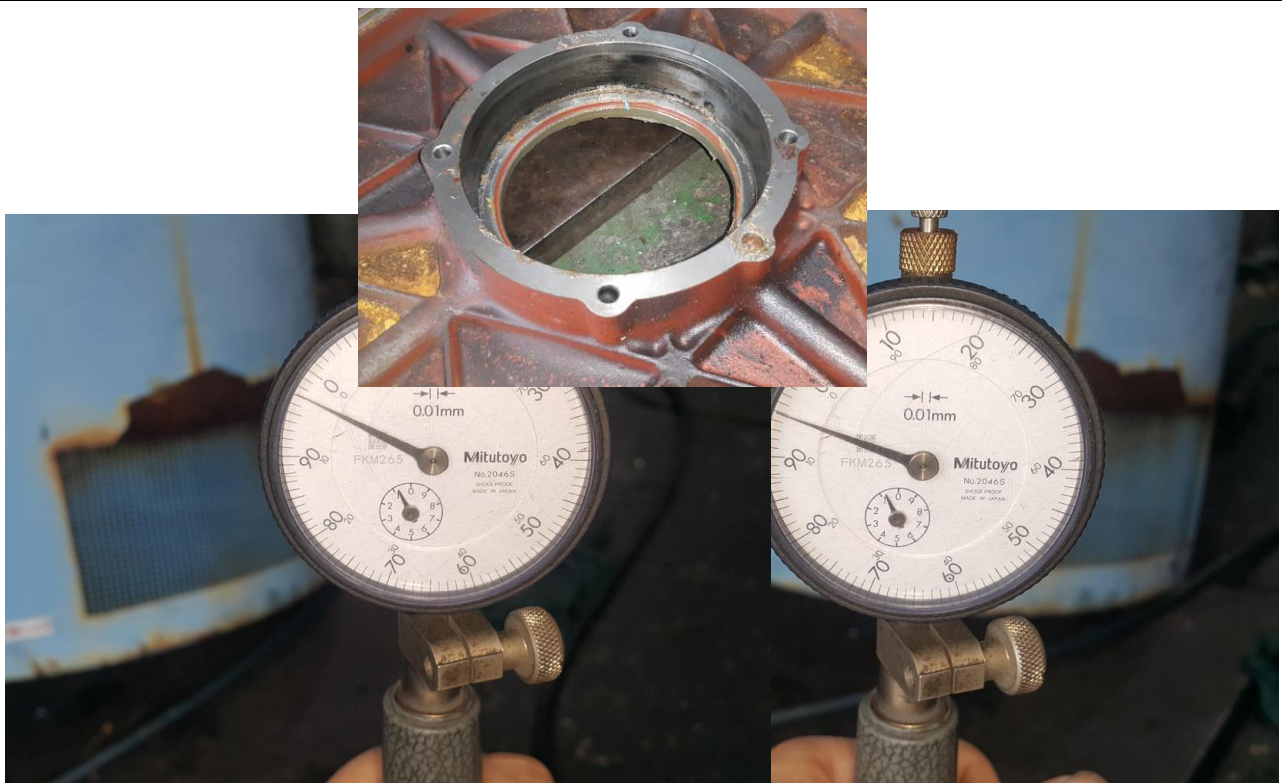

BRACKET	부하측 HOUSING 검사 3~5/100으로 불량
---------	-----------------------------

JIN YANG

작업 공정 사진

작업공정

AC MOTOR 200KW 4P 입고검사

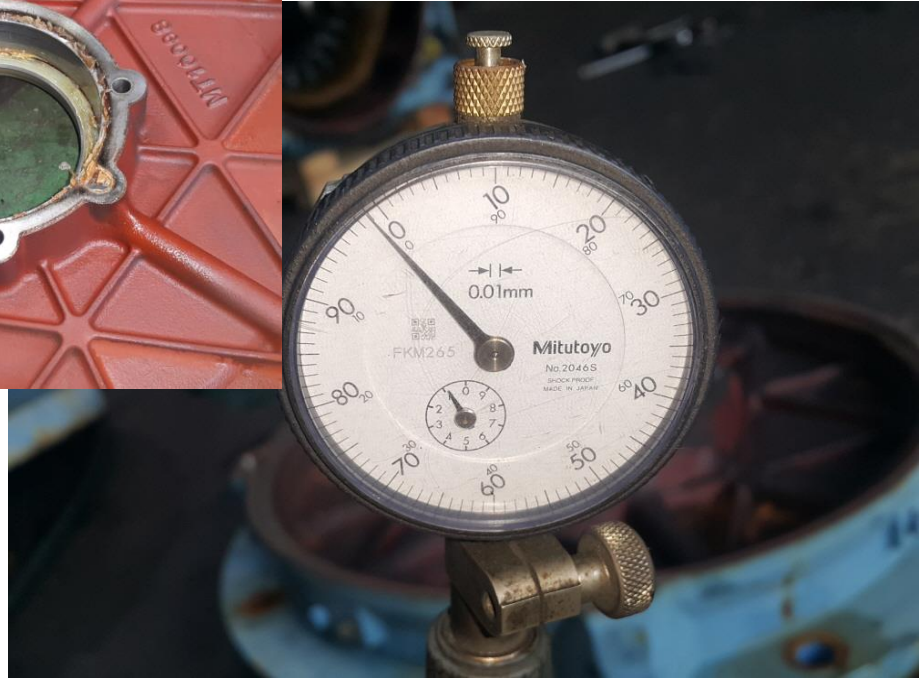

BRACKET

반 부하측 HOUSING 검사 1/100로 재 사용

작업공정

AC MOTOR 200KW 4P 입고검사



ROTOR

분해 후 BALANCING 실시 및 UNBALANCE교정

JIN YANG

작업 공정 사진

작업공정

AC MOTOR 200KW 4P REWINDING



STATOR권체

재 권선 실시

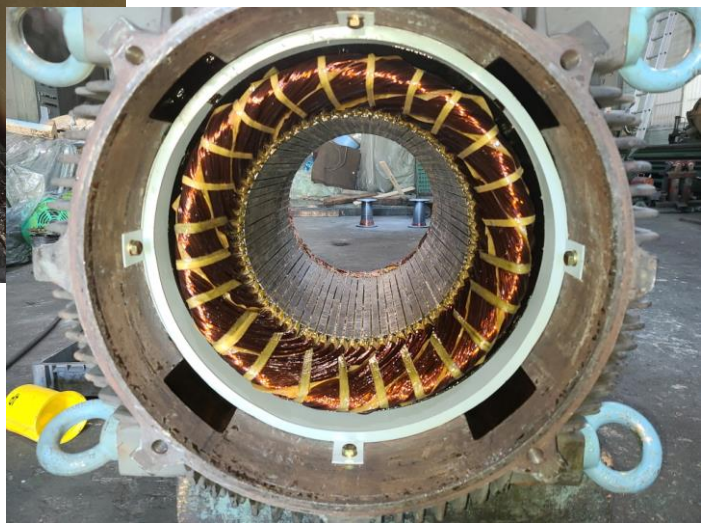

작업공정

AC MOTOR 200KW 4P REWINDING



STATOR권체

INSULATING VARNISH DIPPING DRYING실시

JIN YANG	작업 공정 사진
작업공정	AC MOTOR 200KW 4P REWINDING
	
BRACKET	부하측 HOUSING 보수 후 검사 0/100
작업공정	AC MOTOR 200KW 4P REWINDING
	
FAN COVER	녹 제거 후 방청 도장

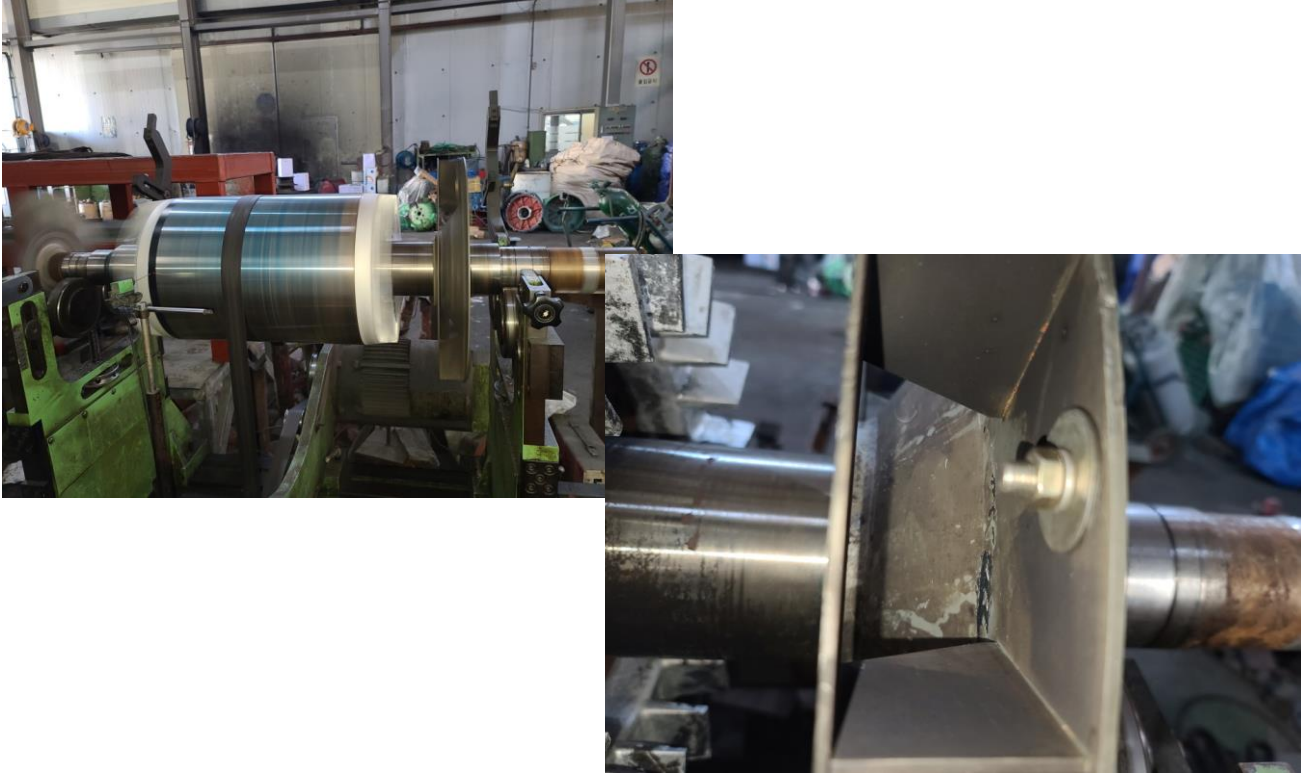
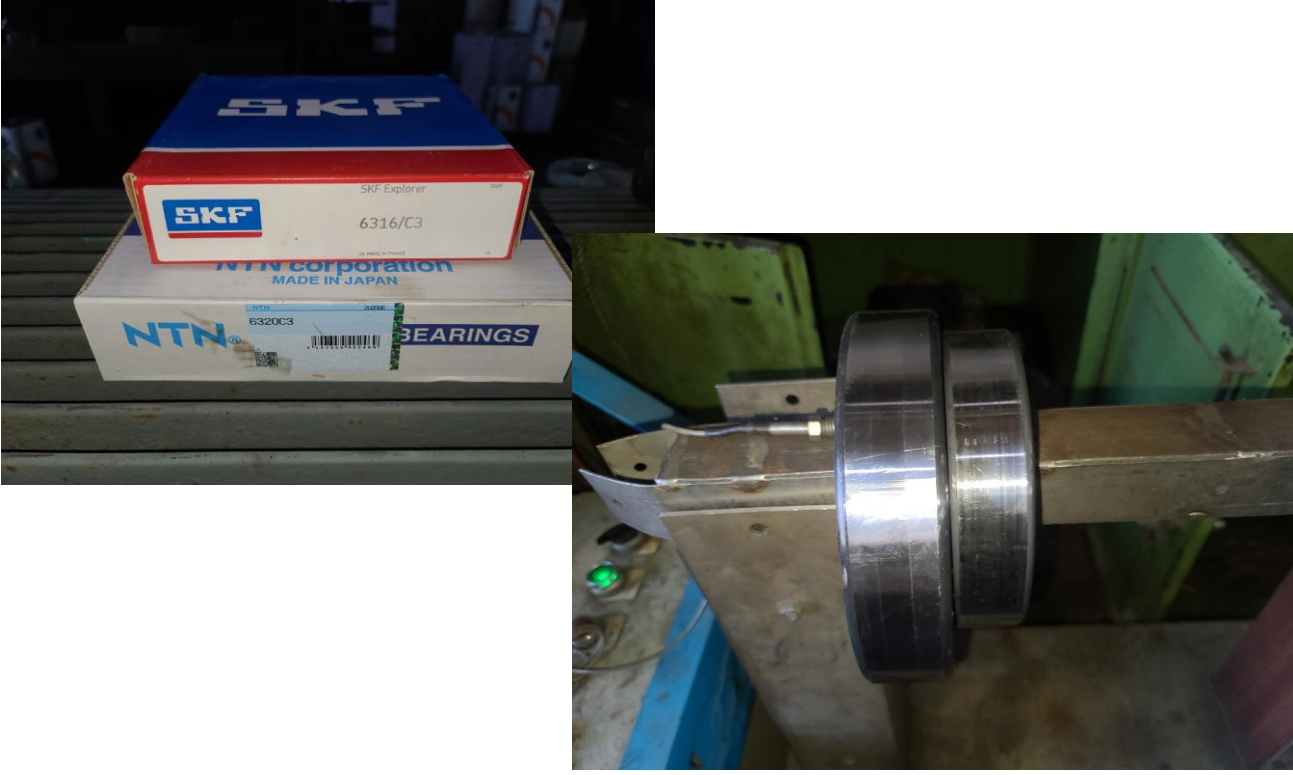
JIN YANG	작업 공정 사진
작업공정	AC MOTOR 200KW 4P REWINDING
	
ROTOR	BALANCING 실시 교정된 UNBALANCE REPORT 참조
작업공정	AC MOTOR 200KW 4P REWINDING
	
소모 품	BEARING 예열 실시

JIN YANG

작업 공정 사진

작업공정

AC MOTOR 200KW 4P REWINDING



Ass'y 조립

GREASE CHARGING 조립 실시

작업공정

AC MOTOR 200KW 4P REWINDING



출고검사

절연저항 & 각 상별 권선저항

JIN YANG

작업 공정 사진

작업공정

AC MOTOR 200KW 4P REWINDING



출고검사

제습 HEATER 절연저항 & 권선저항

작업공정

AC MOTOR 200KW 4P REWINDING



출고검사

제습 HEATER 220V CURRENT

JIN YANG

작업 공정 사진

작업공정

AC MOTOR 200KW 4P REWINDING



출고검사

절연내력 시험

작업공정

AC MOTOR 200KW 4P REWINDING

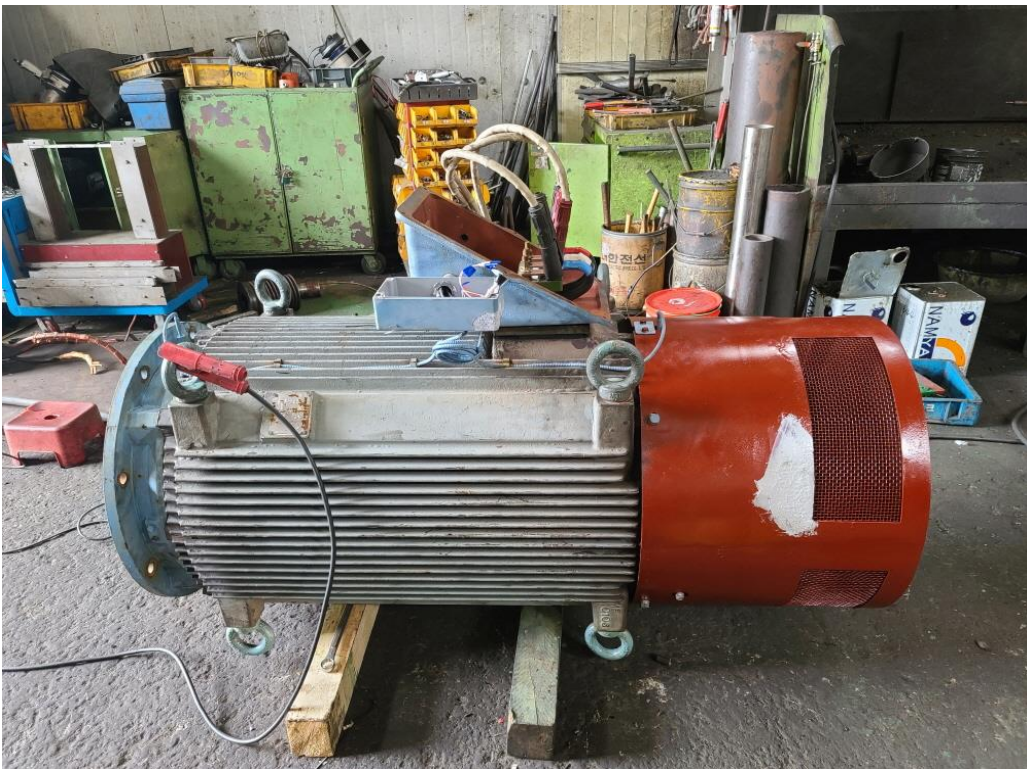

출고검사

시운전 TEST 실시

JIN YANG	작업 공정 사진
작업공정	AC MOTOR 200KW 4P REWINDING



출고검사	시운전 TEST 운전 CURRENT
작업공정	AC MOTOR 200KW 4P REWINDING





부하측

반 부하측



진동검사

출고검사	진동검사
------	------

JIN YANG	작업 공정 사진
작업공정	AC MOTOR 200KW 4P REWINDING
<div style="display: flex; justify-content: space-around;"> <div style="text-align: center;">  <p>운전 소음</p> </div> <div style="text-align: center;">  <p>기본소음</p> </div> </div>	
Ass'y	출고검사 후
작업공정	AC MOTOR 200KW 4P REWINDING
	
출고검사 후	COLOR PAINTING

BALANCING REPORT참조

BALANCING INSPECTION REPORT

SETUP

PART NAME : AC ROTOR 200KW 4P			
CUSTOMER : 한전산업개발(주)삼척사업소			
TEST TIME : 2020. 9.28 9: 7:13			
GRADE	: G 6.3	RATING SPEED	: 1800 rpm
WEIGHT	: 370.000 kg	TESTING SPEED	: 616 rpm
DIAMETER	: 360 mm	CORRECTION	: ADD
ACCEPTABLE UNBALANCE			
PLANE1	: 34.4 gr	PLANE2	: 34.4 gr

INITIAL UNBALANCE

	PLANE1	PLANE2
UNBALANCE	19.3 gr	50.2 gr
ANGLE	67 deg	217 deg
RESULT	ACCEPT	REJECT

CORRECT UNBALANCE

	PLANE1	PLANE2
UNBALANCE	18.5 gr	21.2 gr
ANGLE	118 deg	318 deg
RESULT	ACCEPT	ACCEPT

CORRECT UNBALANCE GRAPH (max = 50.0 gr)

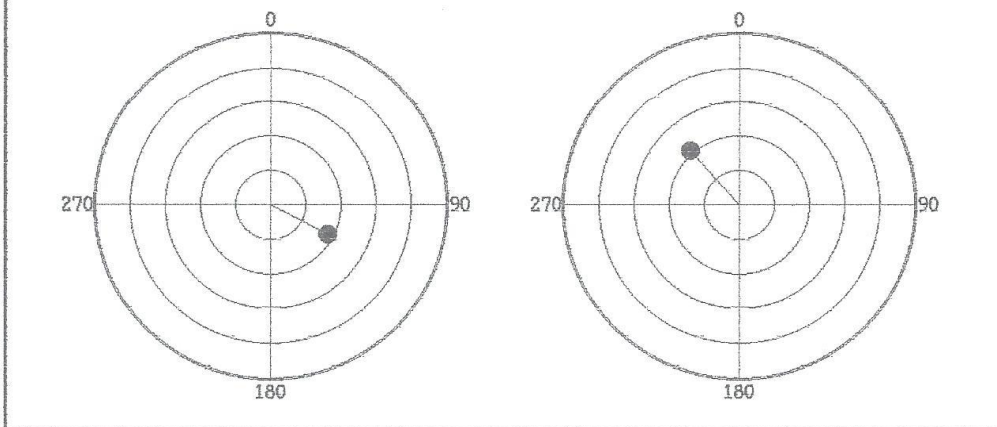

진 양 전 기

경남 마산시 내서읍 중리 1123-3번지

TEL (055) - 231-9318-9

FAX (055) - 231-9314