

작업공정사진철

고객명: (주)

공사명: 압탕절단장 집진기 MOTOR RECONDITION

규격: AC MOTOR 500HP 8P

REPAIR 내역: 분해 조립 및 조립부품 불순물 CLEANSING
INSULATING VARNISH DIPPING DRYING
BALANCING 및 UNBALANCE교정
양측 HOUSING METALLIZING 연마
BEARING 교환
입 출고검사 시운전 TEST 및 COLOR PAINTING



<http://jinyangmotor.com/>

KmR
ISO 9001



JIN YANG

작업 공정 사진

작업공정

AC MOTOR 500HP 8P 입고검사



Ass'y

분해 전

작업공정

AC MOTOR 500HP 8P 입고검사



권선 검사

절연저항 & 각 상별 권선저항

JIN YANG

작업 공정 사진

작업공정

AC MOTOR 500HP 8P 입고검사



Ass'y

분해 실시





작업공정

AC MOTOR 500HP 8P 입고검사



권체

분진 발생

JIN YANG	작업 공정 사진
작업공정	AC MOTOR 500HP 8P 입고검사
	
BRACKET	부하측 HOUSING 측정치 4/100으로 불량
작업공정	AC MOTOR 500HP 8P 입고검사
	
BRACKET	반 부하측 HOUSING 측정치 10/100으로 불량

JIN YANG

작업 공정 사진

작업공정

AC MOTOR 500HP 8P 입고검사



ROTOR

분해 후



작업공정

AC MOTOR 500HP 8P RECONDITION



STATOR권체

스팀 세척 실시

JIN YANG	작업 공정 사진
작업공정	AC MOTOR 500HP 8P RECONDITION
	
STATOR권체	건조 실시
작업공정	AC MOTOR 500HP 8P RECONDITION
	
ROTOR	AIR 분진 청소 실시

JIN YANG

작업 공정 사진

작업공정

AC MOTOR 500HP 8P RECONDITION



ROTOR

BALANCING실시

작업공정

AC MOTOR 500HP 8P RECONDITION

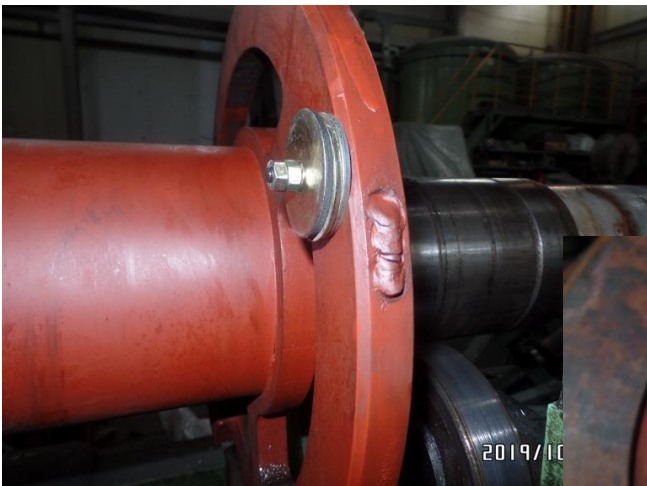

ROTOR

교정된 UNBALACE REPORT참조

JIN YANG	작업 공정 사진
작업공정	AC MOTOR 500HP 8P RECONDITION
	
BRACKET	부하측 HOUSING보수 후 검사
작업공정	AC MOTOR 500HP 8P RECONDITION
	
BRACKET	반 부하측 HOUSING보수 후 검사

JIN YANG	작업 공정 사진
작업공정	AC MOTOR 500HP 8P RECONDITION



소모 품	교환될 BEARING
작업공정	AC MOTOR 500HP 8P RECONDITION



소모 품	BEARING 예열 삽입 GREASE CHARGING 실시
------	----------------------------------

JIN YANG

작업 공정 사진

작업공정

AC MOTOR 500HP 8P RECONDITION



출고검사

절연저항 & 각 상별 권선저항

작업공정

AC MOTOR 500HP 8P RECONDITION



출고검사

시운전 TEST 실시

JIN YANG	작업 공정 사진
----------	----------

작업공정	AC MOTOR 500HP 8P RECONDITION
------	-------------------------------



출고검사	시운전 TEST 운전 CURRENT
------	---------------------

당사 전력 사정상 440V로 RUNNING TEST 실시 하였습니다

작업공정	AC MOTOR 500HP 8P RECONDITION
------	-------------------------------



Ass'y	출고검사 후 COLOR PAINTING
-------	-----------------------

BALANCING INSPECTION REPORT

SETUP

PART NAME : AC ROTOR 375KW 8P			
CUSTOMER : 두산중공업(주)			
TEST TIME : 2019.10.23 8:48:15			
GRADE	: G 6.3	RATING SPEED	: 900 rpm
WEIGHT	: 990.000 kg	TESTING SPEED	: 508 rpm
DIAMETER	: 460 mm	CORRECTION	: ADD
ACCEPTABLE UNBALANCE			
PLANE1	: 143.9 gr	PLANE2	: 143.9 gr

INITIAL UNBALANCE

	PLANE1	PLANE2
UNBALANCE	33.7 gr	117.3 gr
ANGLE	77 deg	238 deg
RESULT	ACCEPT	ACCEPT

CORRECT UNBALANCE

	PLANE1	PLANE2
UNBALANCE	15.0 gr	13.0 gr
ANGLE	82 deg	200 deg
RESULT	ACCEPT	ACCEPT

CORRECT UNBALANCE GRAPH (max = 50.0 gr)

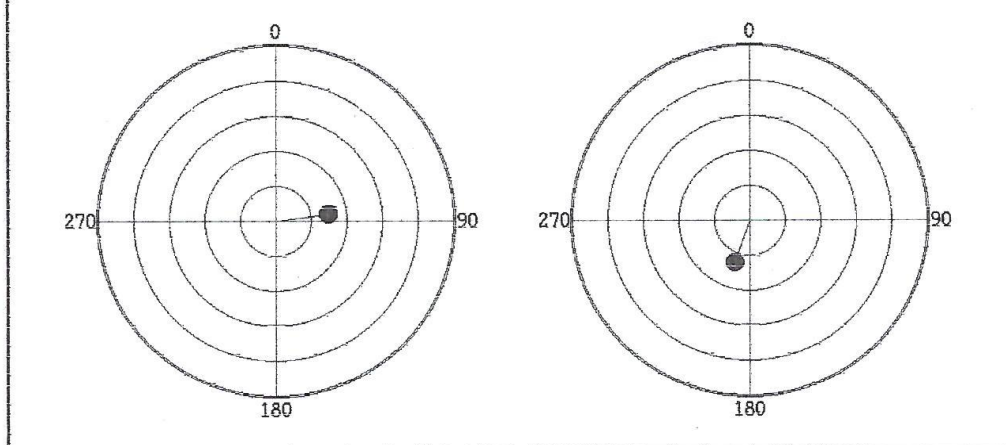

진양전기
 경남 마산시 내서읍 중리 1123-3번지
 TEL (055) - 231-9318-9
 FAX (055) - 231-9314