

작업공정사진철

고객명: 동서식품 (주)

공사명: 기계식냉동기 저단 좌4번 MOTOR보수

규격: 냉동기 COMPRESSOR 440V 288KW 2P

REPAIR 내역: 분해 조립 및 조립부품 불순물 CLEANSING
INSULATING VARNISH DIPPING DRYING
BALANCING 및 UNBALANCE교정
양측 HOUSING METALLIZING 연마
BEARING 교환(사급품)
입 출고검사 시운전 TEST



<http://jinyangmotor.com/>



JIN YANG

작업 공정 사진

작업공정

AC MOTOR 288KW 2P 입고검사



Ass'y

분해 전



작업공정



AC MOTOR 288KW 2P 입고검사



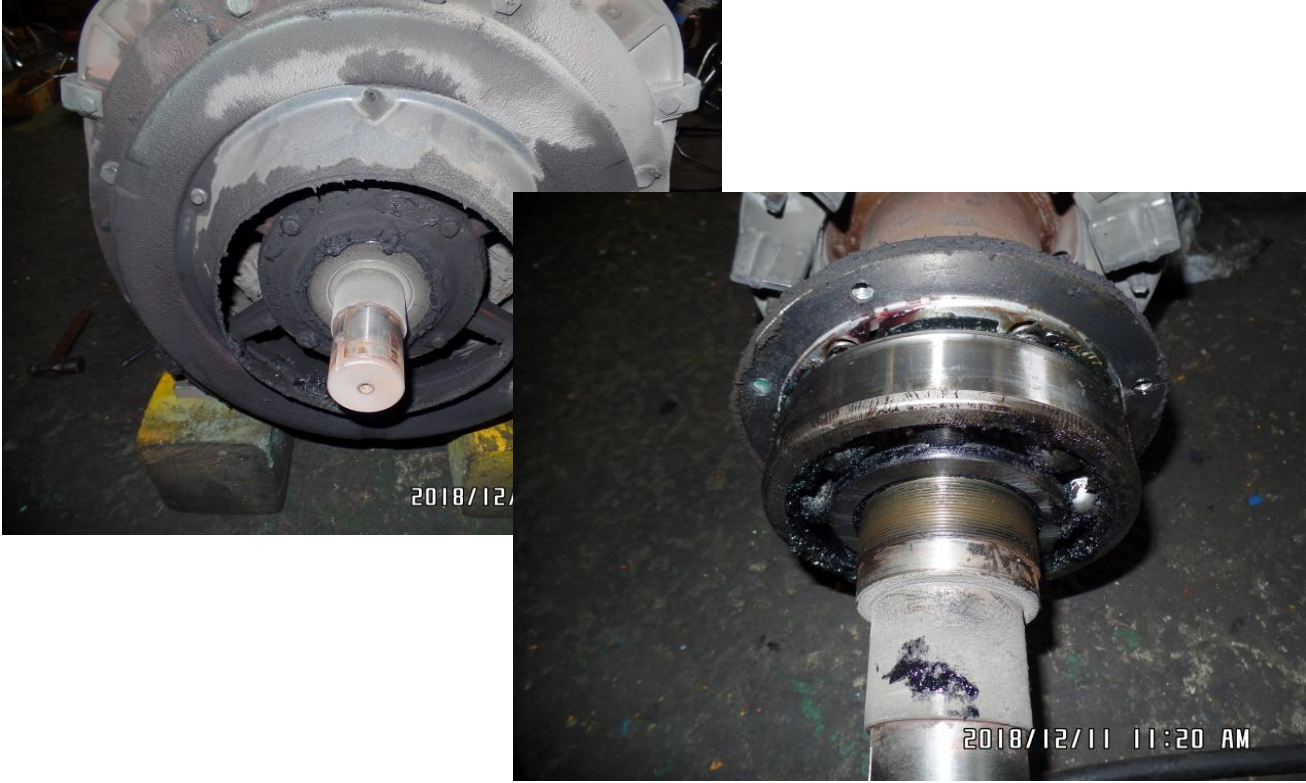

STATOR권선검사

절연저항 & 각 상별 권선저항

JIN YANG	작업 공정 사진
작업공정	AC MOTOR 288KW 2P 입고검사
	
Ass'y	분해 실시
작업공정	AC MOTOR 288KW 2P 입고검사
	
STATOR권체	분해 후

JIN YANG	작업 공정 사진
작업공정	AC MOTOR 288KW 2P 입고검사
 <p data-bbox="858 987 1241 1025">2018/12/11 11:21 AM</p>	
STATOR권체	권선 부
작업공정	AC MOTOR 288KW 2P 입고검사
 <p data-bbox="858 1899 1241 1937">2018/12/11 11:21 AM</p>	
ROTOR	분해 후

JIN YANG	작업 공정 사진
작업공정	AC MOTOR 288KW 2P 입고검사
	
BRACKET	부하측 HOUSING 측정치 4~5/100으로 불량
작업공정	AC MOTOR 288KW 2P 입고검사
	
BRACKET	반 부하측 HOUSING 측정치 2~4/100으로 불량

JIN YANG

작업 공정 사진

작업공정

AC MOTOR 288KW 2P RECONDITION



STATOR권체

스팀세척 실시

작업공정

AC MOTOR 288KW 2P RECONDITION



조립부품

스팀세척 실시

JIN YANG

작업 공정 사진

작업공정

AC MOTOR 288KW 2P RECONDITION



STATOR권체

세척 후 건조실시

작업공정

AC MOTOR 288KW 2P RECONDITION





STATOR권체

URETHANE MODIFIED ACRYLIC COATING실시

JIN YANG	작업 공정 사진
작업공정	AC MOTOR 288KW 2P RECONDITION
	
ROTOR	BALANCING실시 UNBALANCE교정
작업공정	AC MOTOR 288KW 2P RECONDITION
	
소모 품	교환될 신규 BEARING

JIN YANG	작업 공정 사진
작업공정	AC MOTOR 288KW 2P RECONDITION
	
BRACKET	부하측 HOUSING 보수 후 검사
작업공정	AC MOTOR 288KW 2P RECONDITION
	
BRACKET	반 부하측 HOUSING 보수 후 검사

JIN YANG	작업 공정 사진
작업공정	AC MOTOR 288KW 2P RECONDITION
	
소모 품	BEARING 예열 삽입 및 GREASE CHARGING 조립 실시
작업공정	AC MOTOR 288KW 2P RECONDITION
	
출고검사	절연저항 & 각 상별 권선저항

JIN YANG

작업 공정 사진

작업공정

AC MOTOR 288KW 2P RECONDITION



출고검사

시운전 TEST 실시

작업공정

AC MOTOR 288KW 2P RECONDITION



출고검사

시운전 TEST 운전 CURRENT

JIN YANG	작업 공정 사진
작업공정	AC MOTOR 288KW 2P RECONDITION



출고검사	BEARIBG 온도상승 검사
작업공정	AC MOTOR 288KW 2P RECONDITION



출고검사	진동검사
------	------

BALANCING INSPECTION REPORT

SETUP

PART NAME : AC ROTOR 288KW 2P			
CUSTOMER : 동서식품			
TEST TIME : 2018.12.12 13:21: 7			
GRADE	: G 6.3	RATING SPEED	: 3600 rpm
WEIGHT	: 194.000 kg	TESTING SPEED	: 565 rpm
DIAMETER	: 270 mm	CORRECTION	: ADD
ACCEPTABLE UNBALANCE			
PLANE1	: 12.0 gr	PLANE2	: 12.0 gr

INITIAL UNBALANCE

	PLANE1	PLANE2
UNBALANCE	13.0 gr	7.5 gr
ANGLE	10 deg	294 deg
RESULT	REJECT	ACCEPT

CORRECT UNBALANCE

	PLANE1	PLANE2
UNBALANCE	2.0 gr	0.1 gr
ANGLE	326 deg	195 deg
RESULT	ACCEPT	ACCEPT

CORRECT UNBALANCE GRAPH (max = 5.0 gr)

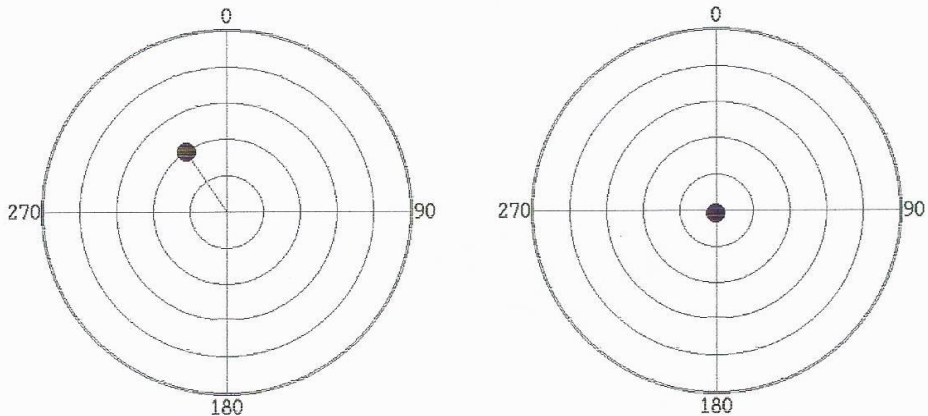

진 양 전 기
 경남 마산시 내서읍 중리 1123-3번지
 TEL (055) - 231-9318-9
 FAX (055) - 231-9314